



Battery Management Innovation



inTELLect **EXP**

**Expandable Electrical
Diagnostic Platform**

*For testing 6 and 12-volt automotive batteries
and 12- and 24-volt charging systems*

INSTRUCTION MANUAL

Contents

Chapter 1: Before You Begin	7
Safety	7
General Precautions	7
Conventions Used in This Manual.....	7
Registering Your Analyzer	8
Chapter 2: Description	9
Test Leads, Connectors, and Data Ports	10
Display and Keypad	11
Data Entry Methods.....	12
Menu icons.....	12
Option Buttons	12
Scrolling Lists	12
Alphanumeric Entry.....	12
Menu Maps.....	13
Main Menu	13
DMM Menu.....	14
Info Menu	15
Print/View Menu	15
Utilities Menu.....	16
Chapter 3: Test Preparation	17
Inspecting the Battery.....	17
Testing Out-of-Vehicle	17
Testing In-Vehicle	17
Connecting the Battery Test Cable.....	17
Connecting an Accessory Cable	18

Setting User Preferences	18
Chapter 4: Battery Test	19
Additional Test Requirements.....	20
Temperature Compensation.....	20
Surface Noise/Unstable Battery	20
Deep Scan Test.....	21
Battery Test Results	22
Chapter 5: 5-Minute Discharged Battery Test.....	23
Test Routine	23
Chapter 6: System Test.....	25
Battery Test	25
Starter Test.....	25
Starter System Test Results.....	26
Alternator Test	27
Alternator Test Results	28
Chapter 7: Cable Drop Test	31
Battery Ground Test	32
Battery Ground Test Results	32
Starter Circuit	33
Starter Circuit Test Results.....	33
Alternator Circuit.....	34
Alternator Circuit Test Results	34
Other Circuit	35
Other Circuit Test Results	35

Chapter 8: Jump Start (System Test)	36
Chapter 9: DMM (Digital Multimeter)	37
DC Volts	37
AC Volts.....	38
Scope	38
DC AMP (requires the optional amp clamp)	39
AC AMP (requires the optional amp clamp)	39
Temp.....	40
Ohm Meter	40
Diode.....	40
Volts/Amp (requires the optional amp clamp).....	41
Chapter 10: Utilities	43
Clock	43
Shop.....	44
Display.....	45
Coupon.....	46
Edit Coupon.....	46
Temp.....	47
Language	47
Format Disk	47
Update.....	47
Chapter 11: Info Menu	48
Totals.....	48
Transfer	48
Version	48

Chapter 12: Print/View	49
View Test	49
View Cable Test.....	49
Chapter 13: Troubleshooting.....	50
The Display Does Not Turn On	50
The STATUS LED Flashes (Midtronics Printer)	50
Data Will Not Print.....	50
Chapter 14: EXP Internal Batteries	52
Battery Power Indicator.....	52
Replacing the EXP Batteries	52
Patents, Limited Warranty, Service.....	53

Chapter 1: Before You Begin

Safety

Because of the possibility of personal injury, always use extreme caution when working with batteries. Follow all manufacturers' instructions and BCI (Battery Council International) safety recommendations.

General Precautions

- **DANGER—RISK OF EXPLOSIVE GASES:** Batteries can produce a highly explosive mix of hydrogen gas and oxygen, even when the battery is not in operation. Always work in a well-ventilated area. Never smoke or allow a spark or flame in the vicinity of a battery.
- **WARNING—REQUIRED BY CALIFORNIA PROP. 65:** Battery posts, terminals, and related accessories contain lead and lead compounds, chemicals known to the state of California to cause cancer and birth defects or other reproductive harm. **Wash hands after handling.**
- Battery acid is highly corrosive. If acid enters your eyes, immediately flush them thoroughly with running cold water for at least 15 minutes and seek medical attention. If battery acid gets on your skin or clothing, wash immediately with water and baking soda.
- Always wear proper safety glasses or face shield when working with or around batteries.
- Keep hair, hands, and clothing as well as the analyzer cords and cables away from moving engine parts.
- Remove any jewelry or watches before you start servicing the battery.
- Use caution when working with metallic tools to prevent sparks or short circuits.
- Never lean over a battery when testing, charging or jump starting it.

Conventions Used in This Manual

To help you learn how to use your EXP analyzer, the manual uses these symbols and typographical conventions:



The safety symbol followed by the word **WARNING** or **CAUTION** indicates instructions for avoiding hazardous conditions and personal injury.

CAUTION

The word **CAUTION** without the safety symbol indicates instructions for avoiding equipment damage.



The wrench symbol indicates procedural notes and helpful information.

UP ARROW

The text for keypad buttons and soft-key functions are in bold capital letters.

POST TYPE

The text for screen options are in regular capital letters.

Registering Your Analyzer

Before using your EXP, we recommend that you register it online to activate your warranty. Registration will also make it faster and easier for you to obtain technical support and service, and order parts and accessories. In addition, you'll be alerted to any important information, like product updates and special offers.

To register, log on at www.midtronics.com/warranty.html and have your serial number ready. The number is at the bottom of the label on the back of the analyzer (*Figure 1*).

If your analyzer needs repair, call Midtronics Customer Service. Servicing the analyzer yourself may void your warranty. Refer to the Limited Warranty section of this manual.



Figure 1:
Serial Number Location

Chapter 2: Description

Every inTELLECT™ EXP model includes a handy, hard-sided, molded carrying case, as shown in *Figure 2*. Regardless of which configuration you choose, the carrying case will hold all accessories, with room for future options, so you can add to your EXP at any time.

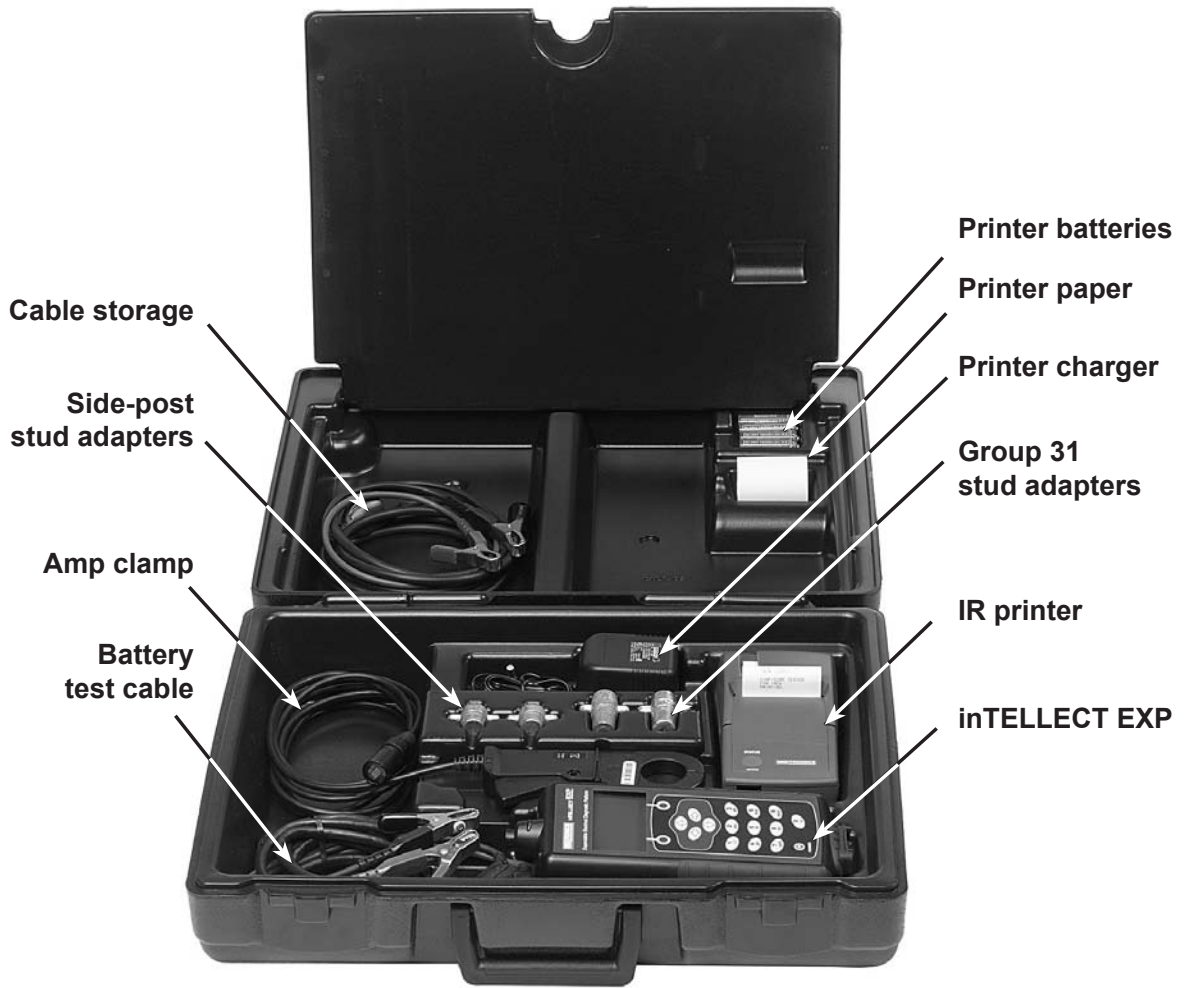

Figure 2: Model EXP-1000 AMP KIT

Test Leads, Connectors, and Data Ports

For the cable test leads (Figure 5), there are two connectors on the top of the EXP (Figure 3).

- For the battery test cable, the EXP has a 6-pin connector with a locking ring.
- For the amp clamp and the multimeter test cables, the EXP has an accessories port, which is a RJ45 connector with a release lever.

Figure 3: Top of EXP

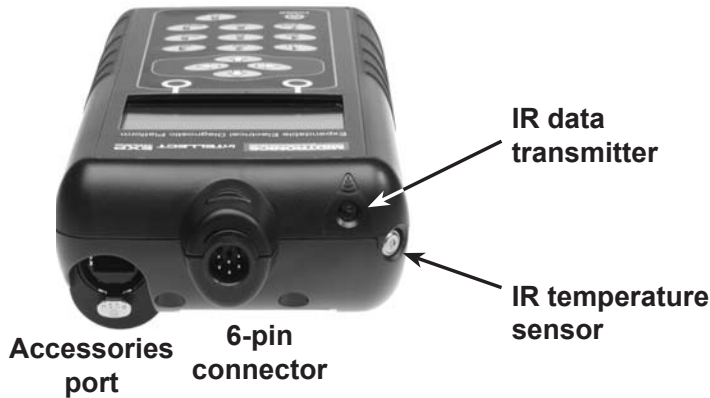

Figure 4: Bottom of EXP

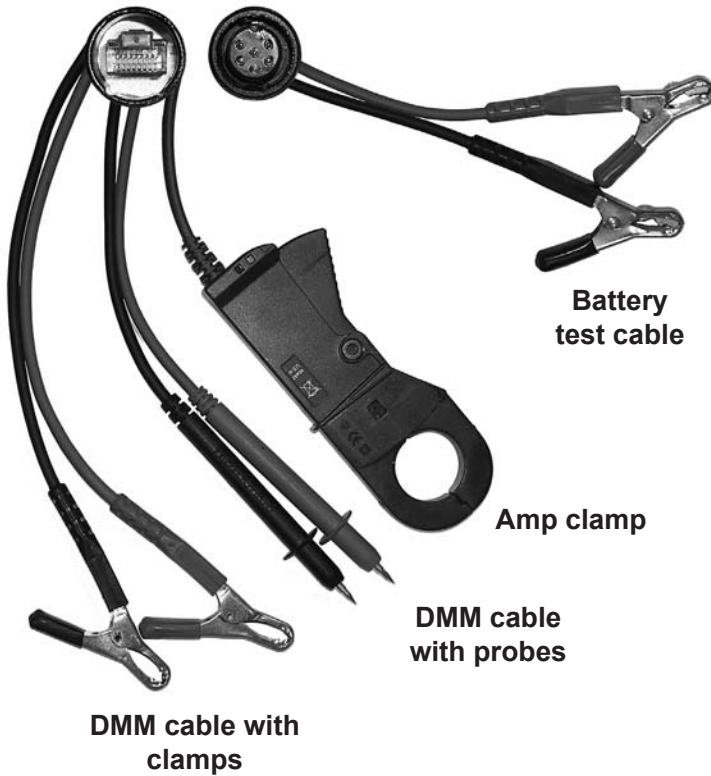

Figure 5: Test Leads

There are two IR data ports on the top of the EXP (Figure 3).

- An IR data transmitter, which transmits test results to the optional IR printer.
- An IR temperature measurement sensor.

The EXP also has a DB-9 connector for future expandability and an SD card slot for future software upgrades or data logging. (Figure 4).

The EXP ships with an unprogrammable card to protect the slot from dust and debris.

Display and Keypad

The EXP keypad and display work together to help you quickly find and use the right tools at the right time. The display also keeps you on track with on-screen navigation aids, directions and messages. *Figure 6* shows how the elements on the screen relate to the keypad.

The **Internal Batteries Status Indicator**, which appears in the screen's top left corner, lets you know the status and charge level of the analyzer's 6 1.5 V batteries. The X shown in the figure shows that the EXP is powered by the battery you're testing to conserve the internal batteries.

Press the two **Soft Keys** linked to the bottom of the screen to perform the functions displayed above them. The functions change depending on the menu or test process. So it may be helpful to think of the words appearing above them as part of the keys. Some of the more common soft-key functions are SELECT, BACK, and END.

When you first connect the EXP to a battery it functions as a voltmeter. The voltage reading appears above the left soft key until you move to other menus or functions.

In some cases, you can use the **Alphanumeric Keypad** to enter numerical test parameters instead of scrolling to them with the **ARROW** keys.

You'll also use the Alphanumeric Keys to create and edit customer coupons. The keypad includes characters for punctuation. To add a space, press the **RIGHT** and **LEFT ARROW** keys simultaneously.

The **Title Bar** shows you the name of the current menu, test tool, utility, or function.

The **Selection Area** below the **Title Bar** contains items you select or into which you enter information. The area also displays instructions and warnings.

The **Directional Arrows** on the display show you which **Arrow Keys** to press to move to other icons or screens. The Up and Down Directional Arrows, for example, let you know to press the **UP** and **DOWN ARROW** keys to display the screens that are above and below the current screen.

The Left and Right Directional Arrows let you know to use the **LEFT** or **RIGHT ARROW** keys to highlight an icon for selection.

Another navigational aid is the **Scroll Bar** along the right side of the screen. The position of its scroll box tells you which menu screen you're viewing.

Scroll Bar

Scroll Box

Top or only screen

Middle screen

Last screen

Press the **POWER** button to turn the EXP on and off. The EXP also turns on automatically when you connect its test leads to a battery.

Whichever way you turn on the EXP, it always highlights the icon and setting you last used for your convenience.

Figure 6: Main Menu and Keypad

Data Entry Methods

To perform a particular test or function, the EXP will ask for different types of information. This means that the methods you use to enter information will change depending on the type of information requested. The four types of entry methods are described below.

Typically, the soft key below the right half of the screen confirms your choice, although the word above it may vary. In *Figure 7*, for example, the word is **SELECT**; in *Figures 8 and 9*, **NEXT**; and in *Figure 10*, **SAVE**. In a similar fashion, the soft key below the left half of the screen cancels your choice or returns you to the previous screen, although the word above it may also vary.

Menu icons

A menu icon is a graphical representation of a function you can select, such as the Diode Icon in the DMM Menu. To select an icon, use the **LEFT** or **RIGHT ARROW** key to highlight it. Highlighting changes the icon to a white picture on a black background as shown in *Figure 7*. To confirm your selection, press the appropriate soft key.

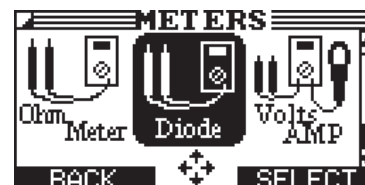

Figure 7: Highlighted Icon

Option Buttons

Some lists have option buttons before each item. To select an item, use the **UP/DOWN ARROW** keys to move the dot into the button next to the item you want. You can also use the alphanumeric keypad to enter the number preceding the option button. To confirm your selection, press the appropriate soft key.

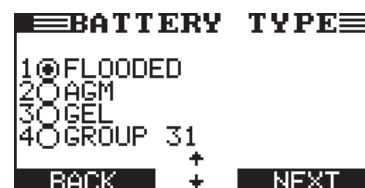

Figure 8: Option Buttons

Scrolling Lists

Scrolling lists contain items that extend above and below the screen or the selection box that contains them. To indicate that there are more items, the symbols \blacktriangleup appear to the right of the first visible or highlighted item on the list.

To select from this type of list, use the **UP/DOWN ARROW** keys to scroll to the item, or use the keypad to enter your choice, and press the appropriate soft key.

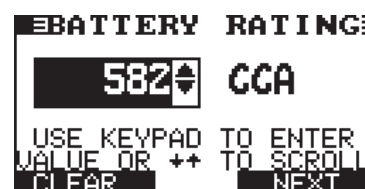

Figure 9: Scrolling List

Alphanumeric Entry

Some selections require you to use the alphanumeric keypad. These “user-defined” selections have a blinking horizontal line (cursor) to the right of the last character (*Figure 10*).

Use the **UP/DOWN ARROW** keys to highlight a line for editing. Display the character, symbol, or number you want by rapidly pressing its key as many times as needed. If you pause, the cursor moves to the right. To backspace, press the **LEFT ARROW** key. Use the **RIGHT ARROW** key to add a space. Use the **UP/DOWN ARROW** keys to highlight a line for editing. When finished, press the appropriate soft key to save your settings.



Figure 10:
Alphanumeric Entry

Menu Maps

This section will help you get to your destination while letting you know what test leads you may need when you arrive. The test leads are represented by symbols for their connectors.

Main Menu

The Main Menu is the starting point for all tools and utilities, which are depicted as icons. Some icons lead directly to the function they represent, while others are menu icons that lead to two or more functions. Menu icons are marked here with an asterisk (*) and are mapped on the following pages.

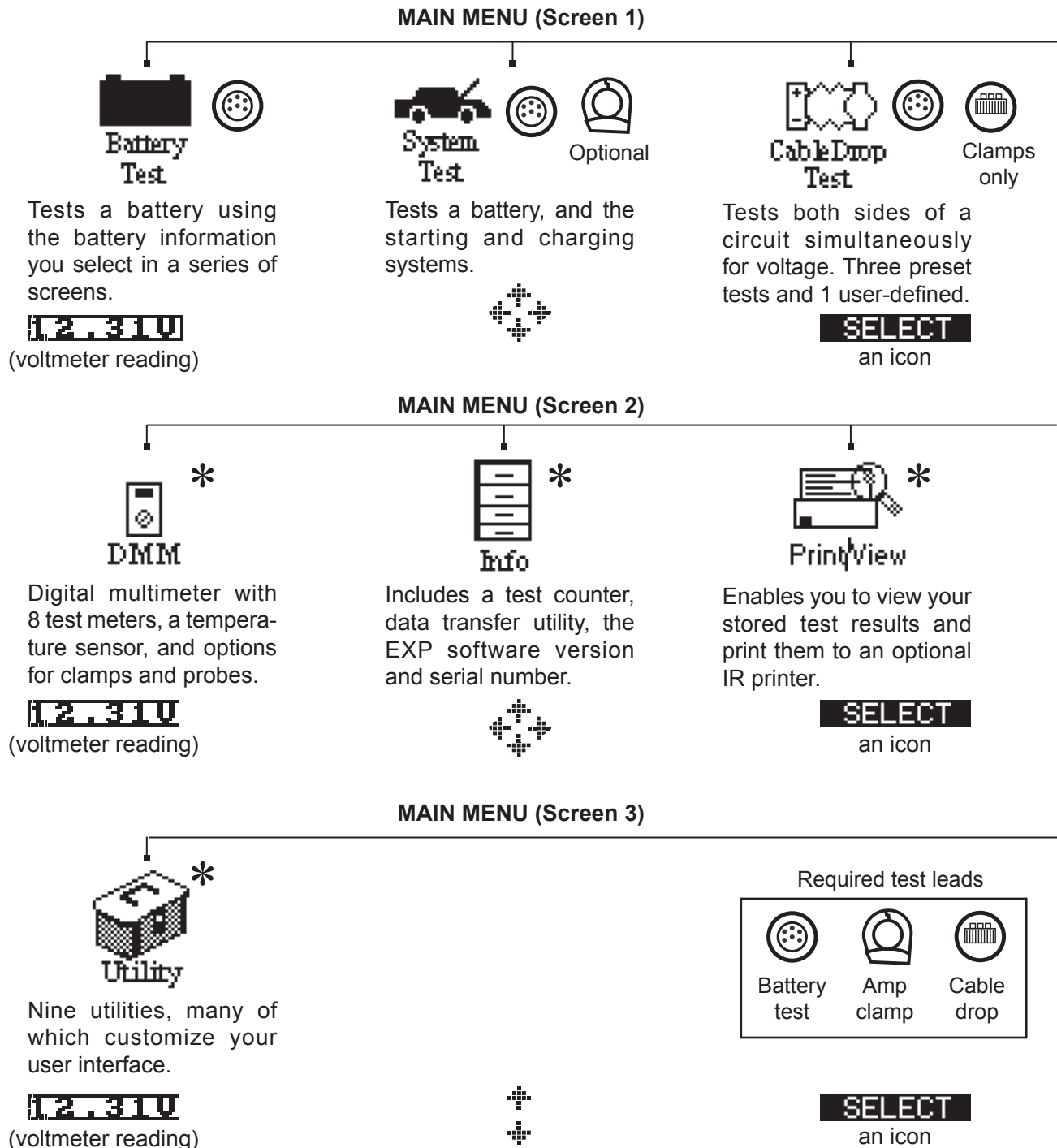

DMM Menu

The DMM Menu has icons for a temperature sensor and 8 test meters, some of which require different test leads. The available leads depend on the EXP model purchased. The cable drop leads with probes is an option that you can purchase separately.

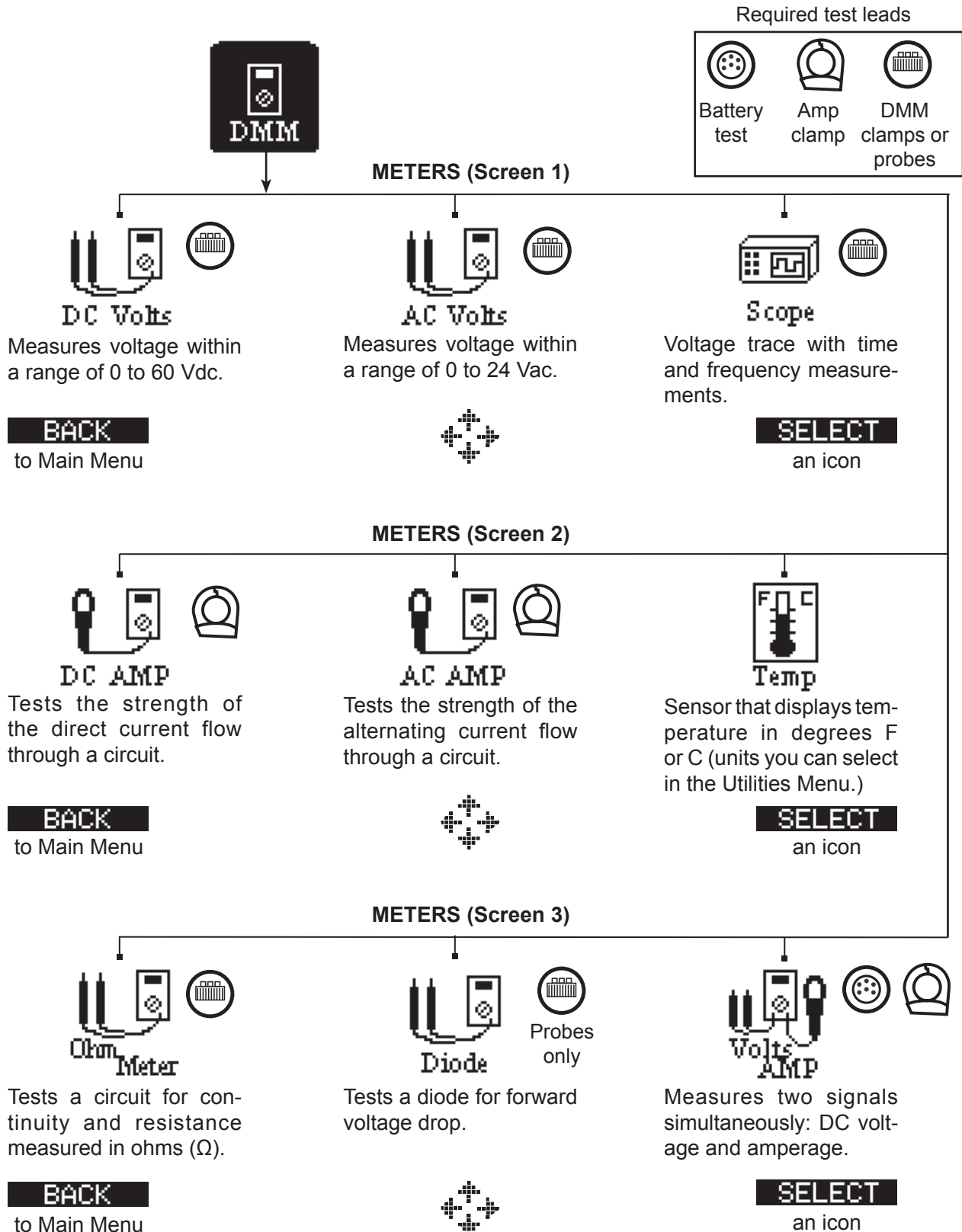

Info Menu

The Info Menu has three utilities to help you manage your test data, and track the usage and history of your EXP analyzer.

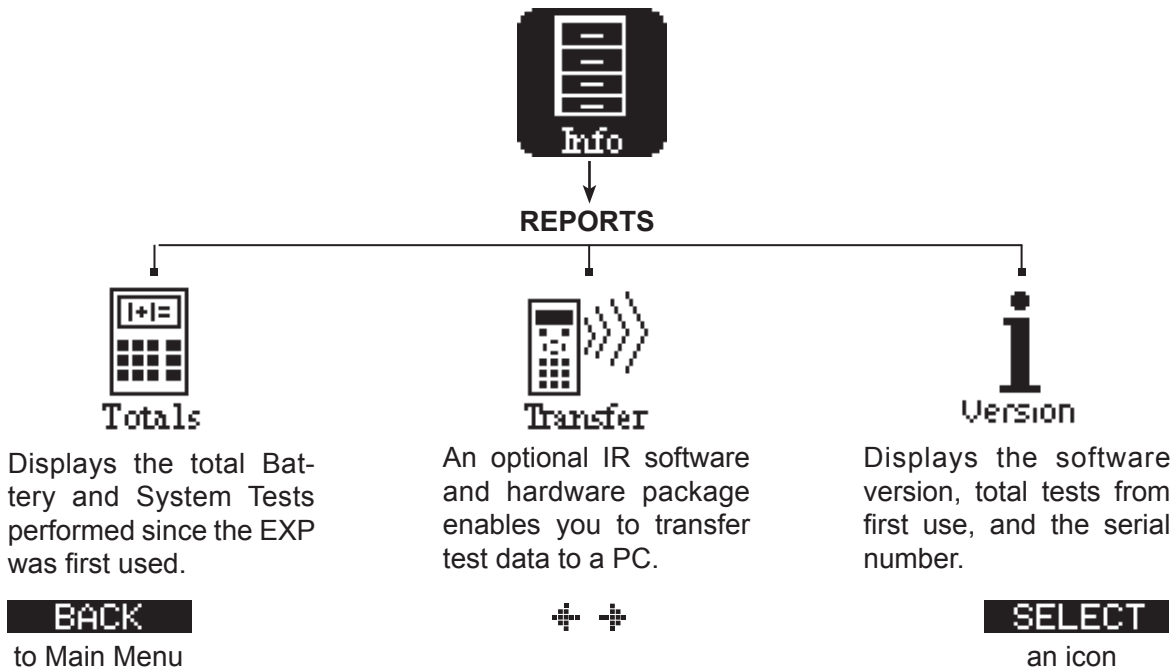

Print/View Menu

The EXP stores the last battery, system, and cable test results in its memory until you perform another test. To review or print results before you retest, select a test type in the Print/View Menu.

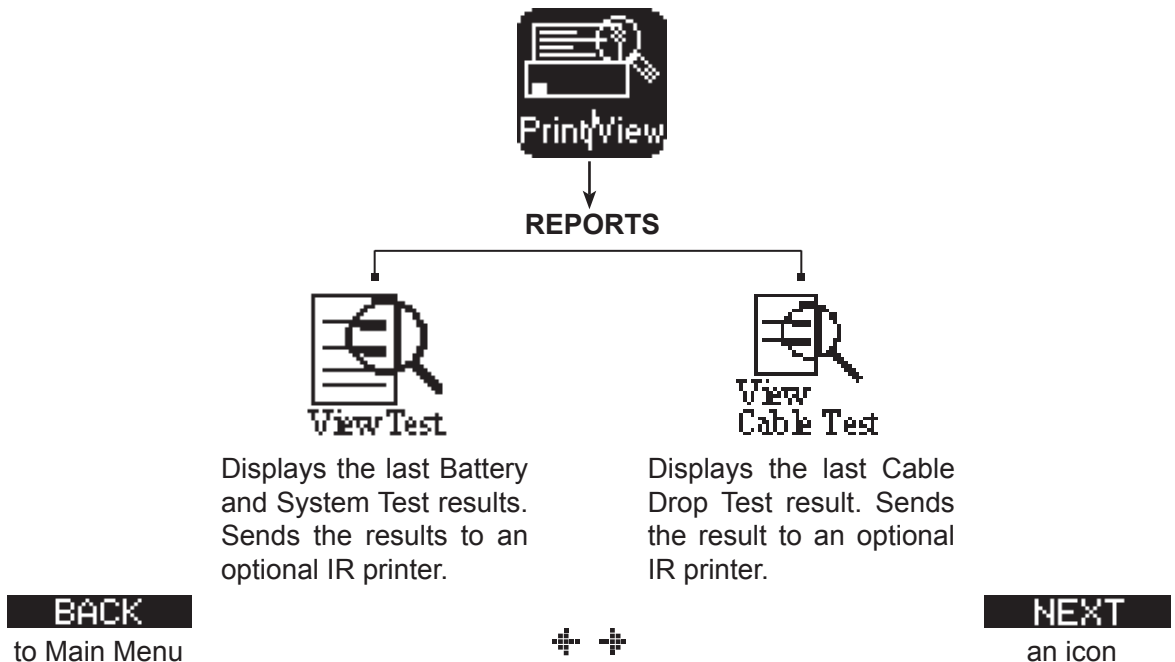

Utilities Menu

The Utilities Menu lets you customize your analyzer to suit your needs. Before testing, check the default values to see what options you may want to change.

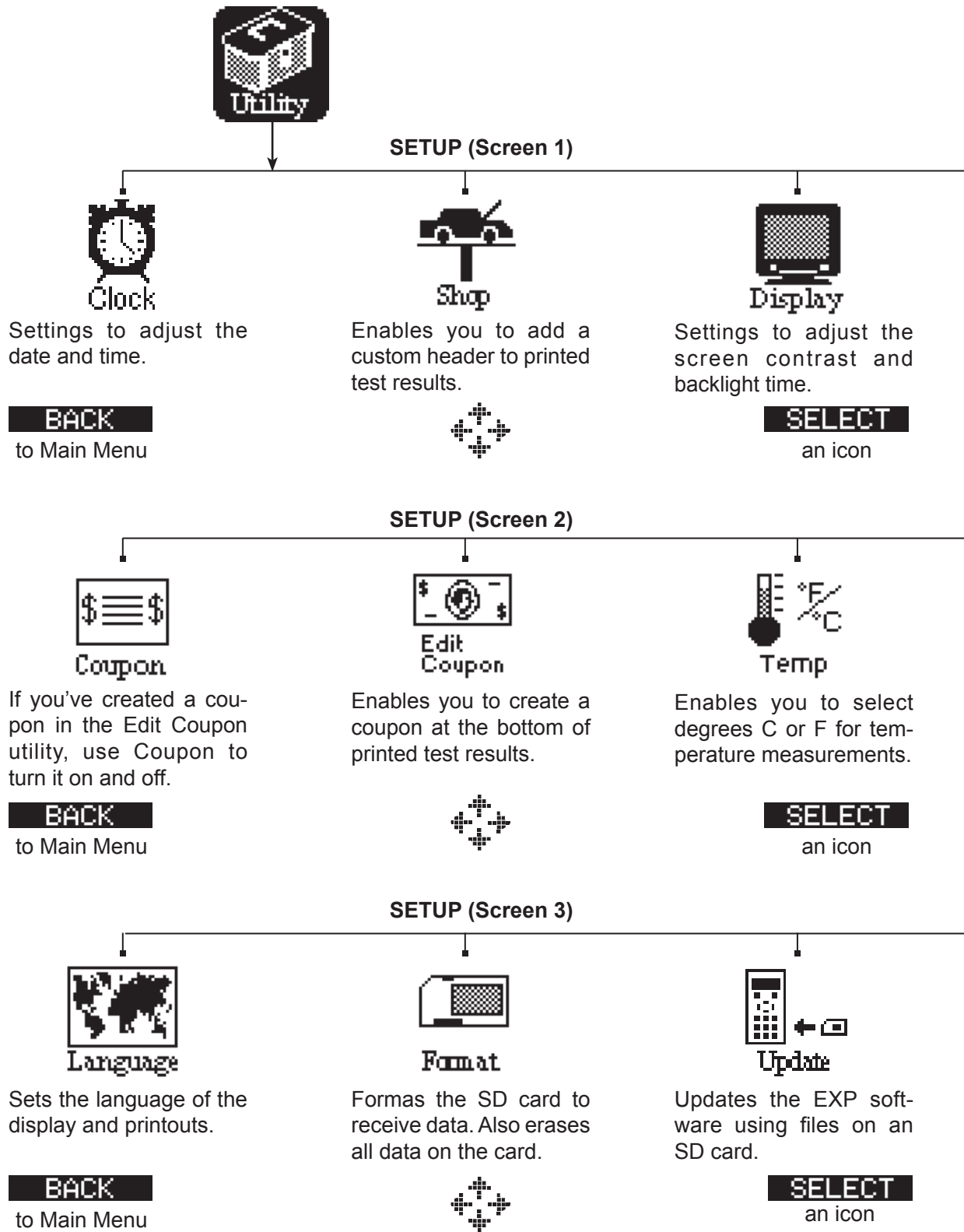

Chapter 3: Test Preparation

Inspecting the Battery

Before starting the test visually inspect the battery for:

- Cracked, buckled, or leaking case. If you see any of these defects, replace the battery.
- Corroded, loose, or damaged cables and connections. Repair or replace them as needed.
- Corrosion on the battery terminals, and dirt or acid on the case top. Clean the case and terminals using a wire brush and a mixture of water and baking soda.
- Low electrolyte level. If the electrolyte level is too low, add distilled water to fill up to 1/2 above the top of the plates and fully charge the battery. Do not overfill.
- Corroded or loose battery tray and hold-down fixture. Tighten or replace as needed.

Testing Out-of-Vehicle

The preferred battery test location is in the vehicle. However, if you plan to test out of the vehicle:

- Always disconnect the negative cable from the battery first and reconnect it last.
- Always use a carry tool or strap to lift and transport the battery.

CAUTION: When testing side-post or group 31 batteries, always test using lead terminal adapters provided with the EXP; do not test at the battery's steel bolts. To avoid damage, never use a wrench to tighten the adapters more than 1/4 turn. Failure to properly install lead terminal adapters, or using adapters that are dirty or worn, may cause false test results.

Testing In-Vehicle

The preferred test position is at the battery posts. If you must test at a remote-post location, it should have both a positive and negative post. Otherwise, you must remove the battery and perform an out-of-vehicle test.

At the start of the test, make sure all vehicle accessory loads are off, the key is not in the ignition, and the doors are closed.

Connecting the Battery Test Cable

CAUTION: Do not connect the EXP to a voltage source greater than 30 Vdc.

Connect the battery test cable to the EXP by first aligning the cable connector's 6 pins with the holes on top of the EXP. Firmly insert the connector and tighten the locking ring.

Connect the clamps to the EXP: the red clamp to the positive (+) terminal and the black clamp to the negative (–) terminal.

If you connect the clamps in the wrong polarity (positive to negative or negative to positive), the EXP displays CLAMPS REVERSED! Reconnect the clamps.

To make sure both sides of the clamps are gripping the terminals, rock the each clamp back and forth. A poor connection will prevent testing, and the EXP will display the message CHECK CONNECTION. If the message reappears after you have correctly reconnected the clamps, clean the terminals and reconnect.

Connecting an Accessory Cable

If you are using an accessory cable, plug it as you would a phone jack into the accessories port on top of the EXP. It locks automatically into the port. To remove it after testing, press the lever and pull the connector out.

Setting User Preferences

Before starting your test you may want to customize the use of your analyzer by setting preferences in the Utility Menu. The menu has settings for the display's date and time, the contrast and backlight time, a utility to customize printouts for the optional IR printer, among others. The utilities are described in Chapter 10.



To conserve the analyzer's internal batteries, the EXP will turn off after 30 seconds of inactivity.

Chapter 4: Battery Test

The EXP will guide you through the steps of selecting your battery test parameters and interpreting the results. Before you start the test, review the instructions in *Chapter 3: Test Preparation*.

1. Select the battery LOCATION.

- 1 OUT OF VEHICLE
- 2 IN VEHICLE

Press the **NEXT** soft key to continue. The **BACK** soft key returns you to the Main Menu at the start of the test and to the previous screen as you progress.

2. Select the POST TYPE. The REMOTE option appears for the IN VEHICLE test.

- 1 TOP
- 2 SIDE
- 3 REMOTE

Press the **NEXT** soft key to continue.

3. Select the BATTERY TYPE.

- 1 REGULAR/AUTO
- 2 AGM
- 3 AGM/SPIRAL
- 4 GEL

Press the **NEXT** soft key to continue.

4. Select the battery's capacity rating standard. The standard, and the rating units required in step 5, are printed on the battery label. If the information is unreadable, contact the battery manufacturer.

- 1 CCA
- 2 CA
- 3 MCA
- 4 JIS
- 5 DIN
- 6 SAE
- 7 IEC
- 8 EN

Press the **NEXT** soft key to continue.

5.  Press the **UP/DOWN ARROW** keys or use the numeric keys to select the RATING UNITS or in the case of JIS, the part number. To increase your scrolling speed, hold down the **UP** or **DOWN ARROW** key.

The default selection is 500 for all rating standards except JIS, which consists of part numbers. The entry range is 100 to 3000 except for DIN and IEC, which has a range of 100 to 1000. If you scroll the values they increase and decrease by 5 units.

Press the **NEXT** soft key to start the test.



For the next few seconds the EXP will display the word TESTING and a stopwatch while it evaluates the battery. The analyzer will also display your selected rating standard and units or JIS part number.

Additional Test Requirements

For a more decisive result the EXP may ask for additional information or probe deeper into the battery's condition. The following messages and instructions may appear before the analyzer displays the results of your test.

Temperature Compensation



Figure 11: Temperature Message

If the analyzer detects that the temperature of the battery may make a difference in the result, it will ask you to measure the battery's temperature with the analyzer's built-in temperature sensor.

The sensor is located in the top left corner of the EXP. An arrow moving diagonally across the display will show you how to angle the EXP so that the sensor is pointed directly at the battery.

Press the **NEXT** soft key to continue.

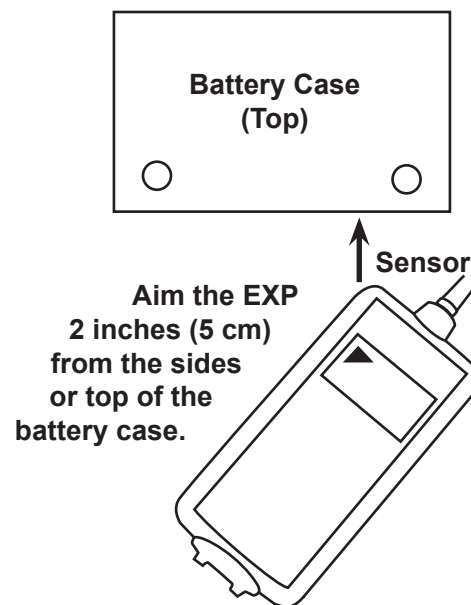

Figure 12:
Aiming the Temperature Sensor

Surface Noise/Unstable Battery

The battery will hold a surface charge if the engine has been running or after the battery has been charged. The analyzer may prompt you to remove the surface charge before it begins testing.

1. Follow the EXP's instructions indicating when to turn the headlights on and off.
2. The analyzer will resume testing after it detects that the surface charge is removed.

Deep Scan Test

In some cases the EXP may need to further analyze the battery to determine whether the battery should be replaced or it has a significant chance to be recovered. It will then conduct a Deep Scan Test of the battery for a few seconds.

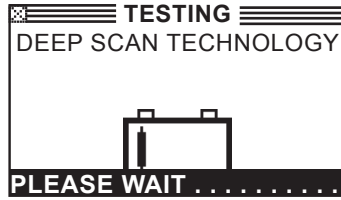

After the Deep Scan Test the EXP will either display the results or give you the option to perform the 5-Minute Discharged Battery Test. Although this test takes several minutes, it gives a more precise result for difficult-to-diagnose batteries. The decision tree of the test is shown below.

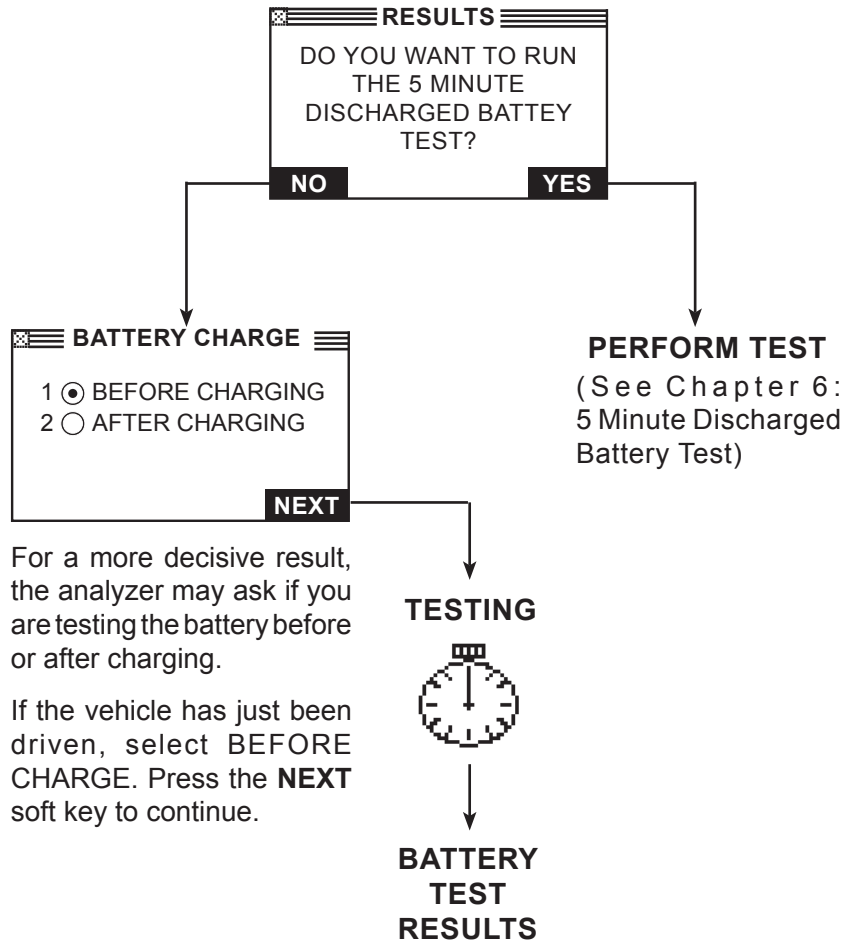

Figure 13: Deep Scan Test and Decision Tree

The next section describes the battery test decisions and suggests actions to take.

Battery Test Results

After the test the EXP will display one of five battery decisions with the complete results in a series of screens as shown in *Figure 14*. Use the **UP/DOWN ARROW** keys to scroll through each result. To send the results to an IR printer, press the **PRINT** soft key. To return to the Main Menu, press the **END** soft key, or to continue testing if you've selected the system text, press the **NEXT** soft key. You'll have the opportunity to print all the results at the end of the system test.

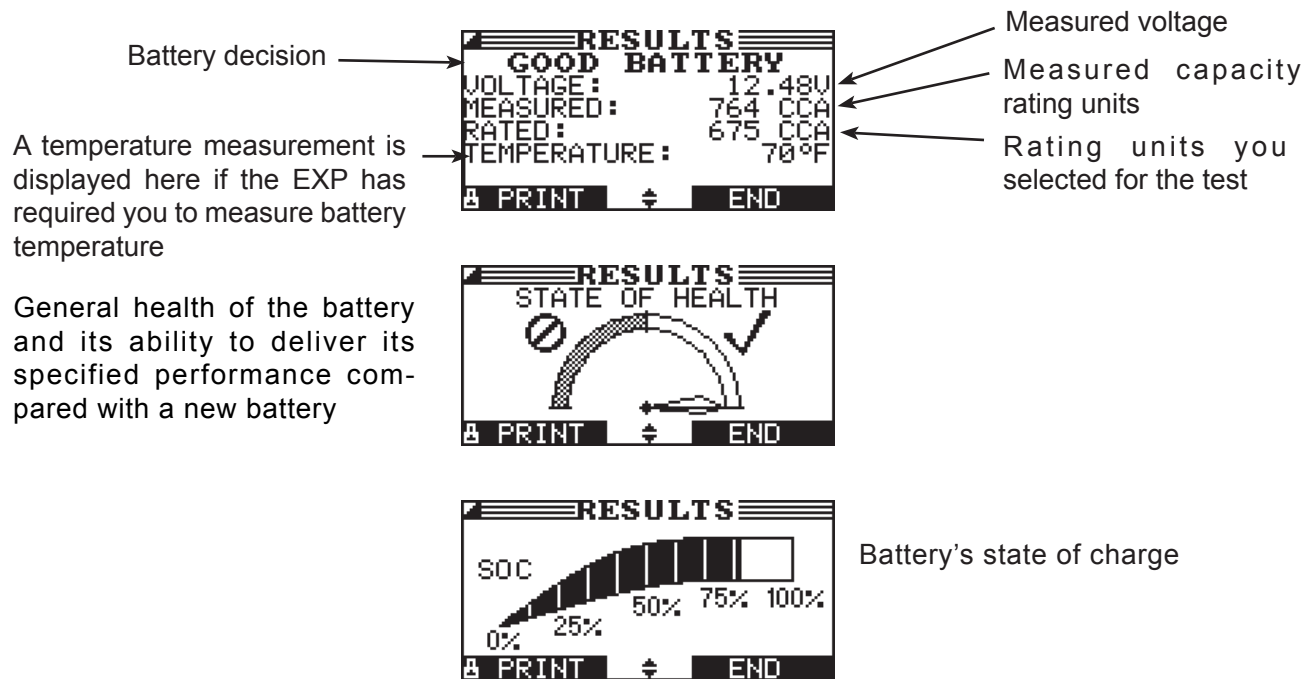

Figure 14: Good Battery Result

Table 1: Battery Decisions and Recommendations

Decision	Recommended Action
GOOD BATTERY	Return the battery to service.
GOOD-RECHARGE	Fully charge the battery and return it to service.
CHARGE & RETEST *	Fully charge the battery and retest. Failure to fully charge the battery before retesting may cause false readings. If CHARGE & RETEST appears again after you fully charge the battery, replace the battery.
REPLACE BATTERY **	Replace the battery and retest. A REPLACE BATTERY result may also mean a poor connection between the battery cables and the battery. After disconnecting the battery cables, retest the battery using the out-of-vehicle test before replacing it.
BAD CELL-REPLACE **	Replace the battery and retest.

* If the result is CHARGE & RETEST, the EXP will calculate and display the time needed to charge the battery at 10, 20, and 40 A.

** When testing at the remote posts, the EXP may need to verify the result. It will give you the option of retesting at the battery posts.

Chapter 5: 5-Minute Discharged Battery Test

This test is an out-of-vehicle dynamic response test in which a deeply-discharged battery can be diagnosed in minutes instead of the hours needed to charge it. The EXP displays the option to perform the test after a deep scan and before it arrives at the battery decision. You can also perform a dynamic response test during the in-vehicle System Test using the vehicle's charging system to apply the charging current.

The test requires an:

- External high-current charger
- Amp clamp

Test Routine

1. Have your amp clamp ready and select AMP CLAMP AVAILABLE.

1 AVAILABLE

2 NOT AVAILABLE

Press the **NEXT** soft key to continue.

2. Select charge current rate of the battery charger you will use for this test.

15  (10–60)

Press the **NEXT** soft key to continue.

3. Disconnect the analyzer's clamps from the battery posts.
4. Make sure the charger's power cord is disconnected and the power switch in the OFF position.
5. Connect the charger's clamps to the battery posts: red lead to the positive (+) terminal, black lead to the negative (–) terminal.
6. Reconnect the analyzer's clamps to the battery posts. Rock them back and forth so they make good contact.
7. Connect the amp clamp to the EXP, and remove the clamp from any cables or wires.
8. Press the **NEXT** soft key to zero out the clamp.
9. Place the amp clamp around the negative (–) battery cable of the charger.
10. Plug in the charger's power cord and turn on the charger.

The EXP will begin testing while the charger applies the charge current to the battery. After the initial boost charge, the EXP will count down the test time in minutes and seconds.



CAUTION: Do not leave the battery unattended while the charger is in operation.

11. When the test is finished, the EXP will ask you to turn off the charger and disconnect the charger and analyzer clamps.
12. Reconnect the EXP clamps to the battery posts and press the **NEXT** softkey to display the battery results (*Table 1*).

Chapter 6: System Test

Before starting the test, inspect the alternator drive belt. A belt that is glazed or worn, or lacks the proper tension, will prevent the engine from achieving the rpm levels needed for the test.

The System Test includes 3 tests that provide a complete diagnosis of the vehicle's electrical system:

- BATTERY TEST
- STARTER TEST
- ALTERNATOR TEST

The System Test includes the option of using an amp clamp.

You also have the option of viewing or printing the results at the end of each test, or at the end of the entire test sequence.

Battery Test

The System Test includes a test of the battery to eliminate it as the cause of starting or charging problems. See Chapter 4 for the Battery Test procedure.

If the EXP determines that the battery needs assistance to start the vehicle, it will prompt you to begin the Jump Start routine described in Chapter 8.

Starter Test

If you are using the amp clamp, keep it clamped around the negative (–) battery cable.

1. Start the engine at the prompt.
2. The EXP will display one of 1 of 7 starter decisions (*Table 2*) with the complete results in a series of screens as shown in *Figure 15*. Use the **UP/DOWN ARROW** keys to scroll to each screen.

To send the results to an IR printer, press the **PRINT** soft key. To continue testing, press the **NEXT** soft key.



NOTE: In some cases, the EXP may not detect the vehicle's starting profile. It will display the soft key options **STARTED** and **NO START**. If you select **STARTED**, the EXP will skip to the alternator test. If you select **NO START**, the test process ends.

Starter System Test Results

Loop ohms (starter loop resistance) displayed if amp clamp used

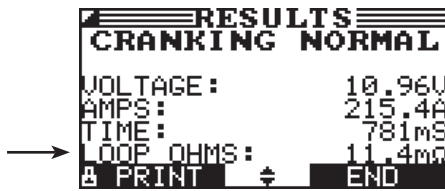

Average cranking voltage

Average cranking current if amp clamp is used

Cranking time in milliseconds

Y axis = System performance: cranking voltage

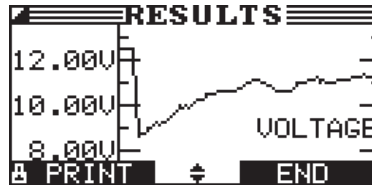

X axis = Time

Y axis = System performance: Cranking current is displayed if amp clamp is used



X axis = Time

Figure 15: Normal Cranking Result

Table 2: Starter System Decisions and Recommendations

Decision	Action
CRANKING NORMAL	The starter voltage is normal and the battery is fully charged.
LOW VOLTAGE	The starter voltage is low and the battery is fully charged.
CHARGE BATTERY	The starter voltage is low and the battery is discharged. Fully charge the battery and repeat the starter system test.
REPLACE BATTERY	(If the battery test result was (REPLACE or BAD CELL.) The battery must be replaced before testing the starter.
LOW CRANKING AMPS	The starter voltage is high but the cranking amps are low.
NO START	The engine didn't start and the test was aborted.
CRANKING SKIPPED	The EXP didn't detect the vehicle's starting profile and skipped the Starter Test.

Alternator Test

1. ANALYZING CHARGING SYSTEM DATA: After you press the **NEXT** soft key to begin the alternator test, the EXP will immediately begin testing for alternator voltage.
2. TURN ALL VEHICLE LOADS OFF, IDLE ENGINE: Turn off vehicle loads (blowers, interior light, radio, etc.) and idle the engine. Press the **NEXT** soft key to continue.



NOTE: If necessary the analyzer will ask if you are testing a diesel engine. It will resume testing after you make your selection.

3. REV ENGINE WITH LOADS OFF FOR 5 SECONDS: Rev the engine with the loads off. Gradually increase the rpm until the analyzer tells you to HOLD the rev level as the bar on the display crosses the rpm target line.



NOTE: Some 8-cylinder and older vehicles idle at a high level after starting, allowing the analyzer to detect the rev automatically.

4. ACQUIRING DATA....HOLD ENGINE RPM: Continue to hold the rpm while the EXP takes system measurements.
5. ENGINE REV DETECTED, IDLE ENGINE: The EXP has detected the rev. Press the **NEXT** soft key to continue.
6. TESTING ALTERNATOR AT IDLE, LOADS OFF: The analyzer will next test the engine at idle for comparison to other readings, and then test the diode ripple. Excessive ripple usually means one or more diodes have failed in the alternator or there is stator damage.
7. TURN HIGH BEAMS AND BLOWER MOTOR ON, IDLE ENGINE: After a few seconds, the EXP will ask you to turn on the accessory loads. It will determine if the charging system is able to provide enough current for the demands of the electrical system.



IMPORTANT: Turn on the high-beam headlights, the blower to high and the rear defogger. Don't use cyclical loads such as air conditioning or windshield wipers.

8. TESTING ALTERNATOR AT IDLE, LOADS ON: The analyzer will determine if the charging system is able to provide sufficient current for the demands of the vehicle's electrical system.
9. REV ENGINE WITH LOADS ON FOR 5 SECONDS: The EXP will test the charging system with the loads on and prompt you to rev the engine. Gradually increase the rev until the analyzer tells you to HOLD the rev level as the bar on the display crosses the rpm target line.
10. ACQUIRING DATA....HOLD ENGINE RPM: Continue to hold the rpm while the EXP takes system measurements.

11. ENGINE REV DETECTED, IDLE ENGINE: The EXP has detected the rev. Press the **NEXT** soft key to continue.
12. ANALYZING CHARGING SYSTEM DATA: The EXP is completing its final analysis of the charging system data.
13. TURN OFF LOADS AND ENGINE: Press the **NEXT** soft key to display the results.

Alternator Test Results

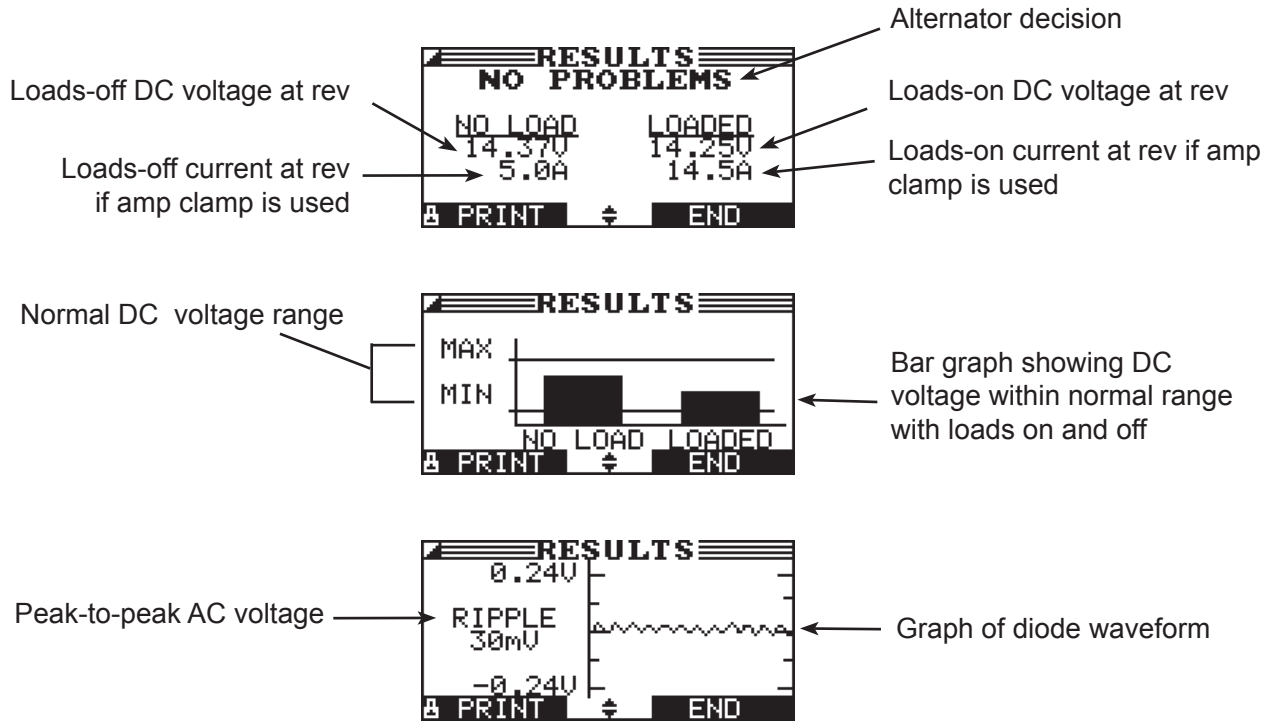

Figure 16: NO PROBLEMS Alternator Result

Table 3: Alternator Decisions and Recommendations

Decision	Action
NO PROBLEMS	The system is showing normal output from the alternator. No problem detected.
NO OUTPUT	<p>The alternator is not providing charging current to the battery.</p> <ul style="list-style-type: none"> √ Check the belts to ensure the alternator is rotating with the engine running. Replace broken or slipping belts and retest. √ Check all connections to and from the alternator, especially the connection to the battery. If the connection is loose or heavily corroded, clean or replace the cable and retest. √ If the belts and connections are in good working condition, replace the alternator. (Older vehicles use external voltage regulators, which may require only replacement of the voltage regulator.)
LOW OUTPUT	<p>The alternator is not providing enough current to power the system’s electrical loads and charge the battery.</p> <ul style="list-style-type: none"> √ Check the belts to ensure the alternator is rotating with the engine running. Replace broken or slipping belts and retest. √ Check the connections from the alternator to the battery. If the connection is loose or heavily corroded, clean or replace the cable and retest.
HIGH OUTPUT	<p>The voltage output from the alternator to the battery exceeds the normal limits of a functioning regulator.</p> <ul style="list-style-type: none"> √ Check to ensure there are no loose connections and that the ground connection is normal. If there are no connection problems, replace the regulator. (Most alternators have a built-in regulator requiring you to replace the alternator. In older vehicles that use external voltage regulators, you may need to replace only the voltage regulator.) <p>The regulator controls voltage output based on the battery voltage, under-hood temperature, and vehicle loads used. In other words, it controls the maximum voltage the system can produce based on the current needs and amount of current that can be produced by the spinning of the rotor in the alternator. The normal high limit of a typical automotive regulator is 14.5 volts +/-0.5. Refer to the manufacturer specifications for the correct limit, which may vary by vehicle type.</p> <p>A high charging rate will overcharge the battery and may decrease its life and cause it to fail. If the battery test decision is REPLACE and the charging system test shows a HIGH OUTPUT, check the battery’s electrolyte levels. A symptom of overcharging is battery fluid spewing through the vent caps, which causes low electrolyte levels and will harm the battery.</p>

Table 4: Diode Decisions and Recommendations

Decision	Action
EXCESSIVE RIPPLE	<p>One or more diodes in the alternator aren't functioning or there's stator damage, which is shown by an excessive amount of AC ripple current supplied to the battery.</p> <p>√ Make sure the alternator mounting is sturdy and that the belts are in good shape and functioning properly. If the mounting and belts are good, replace the alternator.</p>
OPEN PHASE	The EXP has detected an open phase within the alternator. Replace the alternator.
OPEN DIODE	The EXP has detected a open diode within the alternator. Replace the alternator.
SHORTED DIODE	The EXP has detected an shorted diode within the alternator. Replace the alternator.

Chapter 7: Cable Drop Test

If the test results for the starter or charging systems indicate that there may be a problem, you may want to perform the Cable Drop Test to determine if it is due to worn cables or bad connections between the battery and the alternator or starter. Worn cables or bad connections create higher resistance, which causes a drop across the circuit. The voltage drop reduces current carrying capability that displays the same symptoms as a weak alternator or starter and causes premature battery failure.

There's no need to run the engine. The Cable Drop Test uses Midtronics' conductance technology to send a signal through the circuit at the component under test. The EXP then simultaneously calculates voltage drop on the positive (+) and negative (-) sides of any circuit as well as the total voltage drop. The amperage range for each of the four tests is 0 to 1000 A. When you change the setting from the factory defaults, the EXP will store your setting in memory for your next test.

There are three preset tests:

- BATTERY GROUND
- STARTER CIRCUIT
- ALTERNATOR CIRCUIT

A fourth test, OTHER CIRCUIT, tests other grounds and circuits against your specified amperage capacity.

The test requires two test lead connections, as shown in *Figure 17*:

- Battery test leads at the component's output lead (the B+ or output screw on the alternator) and the component's housing as ground
- DMM test leads at the battery terminals



NOTE: The test requires a complete circuit. If you're testing a system with a remote solenoid, you can test from the battery to the solenoid, but not from the battery to the starter.

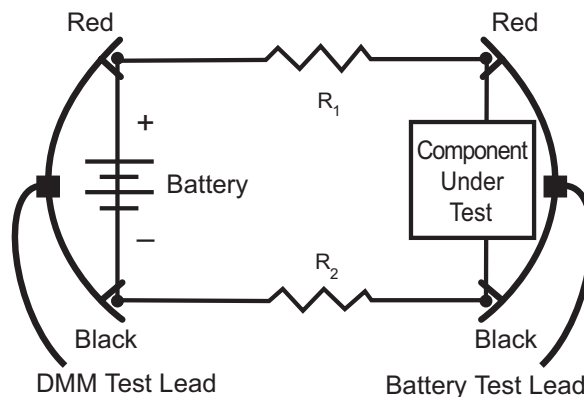

Figure 17: Connections for the Cable Drop Test

To begin, select the Cable Drop Test icon in the Main Menu and follow the instructions on the display.



IMPORTANT: For accurate results the battery should be good and fully charged before you perform a test.

Battery Ground Test

The Battery Ground Test measures the voltage drop for the ground strap.

1. **SELECT CIRCUIT:** Use the **UP/DOWN ARROWS** or the numerical keypad to select the Battery Ground Test.
 - 1 BATTERY GROUND
 - 2 STARTER CIRCUIT
 - 3 ALT CIRCUIT
 - 4 OTHER

Press the **NEXT** soft key to continue.

2. **SET AMPS:** Use the **UP/DOWN ARROWS** or the keypad to select the rated amperage of the circuit you are testing. The default is 80 A.



Press the **NEXT** soft key to continue.

3. Connect the main clamps (battery test leads) to the battery and ground: positive (+) clamp to the battery's positive post; negative (-) clamp to the vehicle chassis.
4. Connect the DMM cable to the battery posts: positive (+) clamp to the positive post; negative clamp (-) to the negative post.



For the next few seconds the EXP will display the word **TESTING** and a stopwatch while it evaluates the battery ground.

Battery Ground Test Results

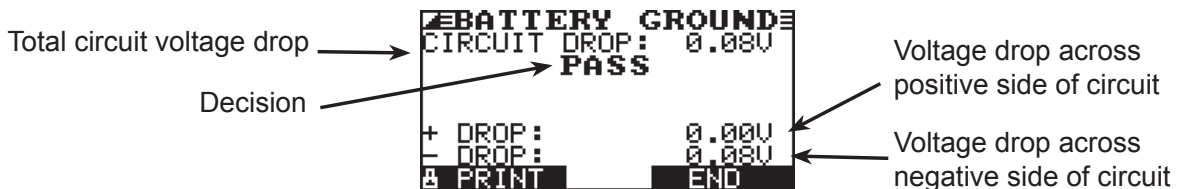

Figure 18: Battery Ground Test PASS Result

If there is a problem, the decision is **CLEAN AND RETEST OR REPLACE**. To print the results, align the EXP's IR transmitter with the printer's receiver, and select the **PRINT** soft key. To return to the Main Menu, press the **END** key.

Starter Circuit

The Starter Circuit Test measures the voltage drop of the starter circuit.

1. **SELECT CIRCUIT:** Use the **UP/DOWN ARROWS** or the numerical keypad to select **STARTER CIRCUIT**.
 - 1 BATTERY GROUND
 - 2 **STARTER CIRCUIT**
 - 3 ALT CIRCUIT
 - 4 OTHER

Press the **NEXT** soft key to continue.

2. **SET AMPS:** Use the **UP/DOWN ARROWS** or the keypad to select the rated amperage of the starter circuit. The default is 150 A.



Press the **NEXT** soft key to continue.

3. Connect the positive (+) clamp of the battery test leads to the starter’s battery terminal stud. Connect the negative (-) clamp to the starter’s housing.
4. Connect the positive (+) DMM clamp to the battery’s positive (+) post. Connect the negative clamp (-) to the battery’s (-) negative post.



For the next few seconds the EXP will display the word **TESTING** and a stopwatch while it evaluates the battery ground.

Starter Circuit Test Results



Figure 19: Starter Circuit PASS Result

If there is a problem, the decision is **CLEAN AND RETEST OR REPLACE**. To print the results, align the EXP’s IR transmitter with the printer’s receiver, and select the **PRINT** soft key. To return to the Main Menu, press the **END** key.

Alternator Circuit

The Alternator Circuit Test measures the voltage drop of the alternator circuit.

1. SELECT CIRCUIT: Use the **UP/DOWN ARROWS** or the numerical keypad to select ALT CIRCUIT.
 - 1 BATTERY GROUND
 - 2 STARTER CIRCUIT
 - 3 ALT CIRCUIT
 - 4 OTHER
 Press the **NEXT** soft key to continue.

2. SET AMPS: Use the **UP/DOWN ARROWS** or the keypad to select the rated amperage of the alternator circuit. The default is 80 A.

80  **A**

Press the **NEXT** soft key to continue.

3. Connect the positive (+) clamp of the battery test leads to the alternator's output stud (B+). Connect the negative (-) clamp to the alternator's housing.
4. Connect the positive (+) DMM clamp to the battery's positive (+) post. Connect the negative clamp (-) to the battery's (-) negative post.



For the next few seconds the EXP will display the word TESTING and a stopwatch while it evaluates the battery ground.

Alternator Circuit Test Results

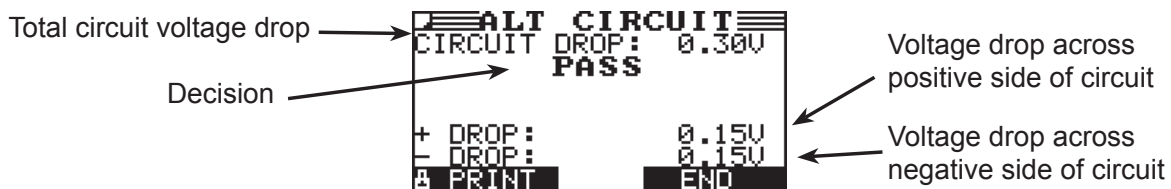

Figure 20: Alternator Circuit PASS Result

If there is a problem, the decision is CLEAN AND RETEST OR REPLACE. To print the results, align the EXP's IR transmitter with the printer's receiver, and select the **PRINT** soft key. To return to the Main Menu, press the **END** key.

Other Circuit

This test enables you to measure voltage drop across other components.

1. **SELECT CIRCUIT:** Use the **UP/DOWN ARROWS** or the numerical keypad to select the **OTHER**.
 - 1 BATTERY GROUND
 - 2 STARTER CIRCUIT
 - 3 ALT CIRCUIT
 - 4 **OTHER**

Press the **NEXT** soft key to continue.

2. **SET AMPS:** Use the **UP/DOWN ARROWS** or the keypad to select the rated amperage of the circuit you are testing. The default is 10 A.



Press the **NEXT** soft key to continue.

3. Connect the positive (+) clamp of the battery test leads to the component's positive terminal (+). Connect the negative (-) clamp to the component's negative (-) terminal.
4. Connect the positive (+) DMM clamp to the battery's positive (+) post. Connect the negative clamp (-) to the battery's (-) negative post.



For the next few seconds the EXP will display the word **TESTING** and a stopwatch while it evaluates the battery ground.

Other Circuit Test Results

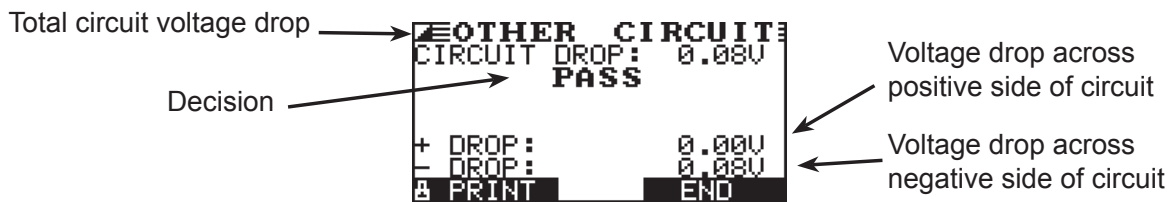

Figure 21: Other Circuit PASS Result

If there is a problem, the decision is **CLEAN AND RETEST OR REPLACE**. To print the results, align the EXP's IR transmitter with the printer's receiver, and select the **PRINT** soft key. To return to the Main Menu, press the **END** key.

Chapter 8: Jump Start (System Test)

The EXP's Jump Start routine assists a discharged battery so that you can complete the Starter Test portion of the System Test.

1. When the JUMP START instruction screen is displayed, disconnect the analyzer's clamps from the battery posts.
2. Make sure the charger's power cord is disconnected and the power switch in the OFF position.
3. Connect the charger's clamps to the battery posts: red lead to the positive (+) terminal, black lead to the negative (-) terminal.
4. Reconnect the analyzer's clamps to the battery posts. Rock them back and forth so they make good contact.
5. Turn on the booster pack or charger.
6. The EXP will monitor the level of the battery's voltage for a maximum of 30 seconds.
7. When the time counts down to 0 seconds or the battery voltage is sufficient, the EXP will instruct you to start the engine.
8. The EXP will display the Starter Test results (See *Table 2*).
9. Disconnect the booster pack or battery charger.

The EXP will continue with the alternator test.

Chapter 9: DMM (Digital Multimeter)

The EXP's 8 digital meters make it versatile enough to test everything from a vehicle's entire electrical system to a board-level component:

- DC Voltmeter
- AC Voltmeter
- Scope
- DC Ammeter
- AC Ammeter
- Ohmmeter
- Diode Drop
- Volts/Amp

The DMM's infrared temperature sensor also enables you to determine the surface temperature of components before you service them or as a diagnostic aid. Specifications for each tool are listed at the end of this chapter in *Table 5*.

Select the DMM icon to display its METERS menu. The tools in this menu are available in a series of three screens.

A measurement that is out of the limit displays as *OL*. Refer to the manufacturer specifications for the correct limits, which may vary by component or vehicle type.

DC Volts

The DC voltmeter measures voltage between two points in a circuit. The voltmeter is connected in parallel with the circuit.

1. Connect the DMM test lead to the EXP's accessories port.
2. Select the meter's icon.
3. Connect the clamps or probes in the correct polarity: red clamp or probe to positive (+); black to negative (-).
4. The meter will autorange and display the measurement.
5. To return to the METERS menu, press the **END** soft key.

AC Volts

The AC voltmeter measures the AC volts between two points in a circuit. The voltmeter is connected in parallel with the circuit.

1. Connect the DMM test lead to the EXP's accessories port.
2. Select the meter's icon.
3. Connect the clamps or probes in the correct polarity: red clamp or probe to positive (+); black to negative (-).
4. The meter will autorange and display the measurement.
5. To return to the METERS menu, press the **END** soft key.

Scope

The scope is a voltmeter that provides a graph of voltage difference as it varies over time. After you select the scope icon, note the instructions in the next screen before proceeding. You'll need the them after you press the **SELECT** soft key to continue:

- Press 1 on the keypad to autoscale the scope.
- Press 3 on the keypad for the time display.
- Press 4 on the keypad for the FFT (frequency) display.

Press the **SELECT** soft key to continue.

In the time display the horizontal axis is in seconds and the vertical axis is in volts.

In the frequency display the horizontal axis is in hertz and the vertical axis is in volts.

Press the right soft key to alternate between the options to **RUN** (measure and display the signal) and **HOLD** (freeze the signal).

The scope enables you to print the voltage trace to the optional IR printer when you freeze the signal. Align the EXP's IR transmitter with the printer's receiver, and select the **PRINT** soft key.

To return to the METERS menu, press **END**.

DC AMP (requires the optional amp clamp)

The DC ammeter measures DC magnitude and flow of the DC current in a circuit.

1. Connect the amp clamp lead to the EXP's accessories port.
2. Select the meter's icon.
3. Select the amp clamp range.
 - 1 70 AMP MAX.
 - 2 700 AMP MAX.Press the **NEXT** soft key to continue.
4. The meter will zero itself.
5. Place the clamp's jaws around the negative (-) cable.
6. The EXP will display the measurement.
7. To return to the METERS menu, press the **END** soft key.

AC AMP (requires the optional amp clamp)

The DC ammeter measures the magnitude and flow of the AC current through a circuit during normal operations.

1. Connect the amp clamp lead to the EXP's accessories port.
2. Select the meter's icon.
3. Select the amp clamp range.
 - 1 70 AMP MAX.
 - 2 700 AMP MAX.Press the **NEXT** soft key to continue.
4. The meter will zero itself.
5. Place the clamp's jaws around the negative (-) cable.
6. The EXP will display the measurement.
7. To return to the METERS menu, press the **END** soft key.

Temp

The IR temperature sensor measures surface temperature within a range of –20 to 200 °C. The tool can be used for checking the transmission for overheating, and the temperature levels of the heater and air conditioner. *Figure 12* shows how to aim the EXP's temperature sensor at a component you are testing.

Ohm Meter

The meter is connected in parallel with the circuit under test and uses the power supplied by the EXP's internal batteries to detect open or excessive resistance.

CAUTION: Always remove power from the circuit before connecting the ohmmeter to avoid damaging the analyzer.

1. Connect the DMM test lead to the EXP's accessories port.
2. Select the meter's icon.
3. Connect the clamps or probes in the correct polarity: red clamp or probe to positive (+); black to negative (–).
4. The meter will autorange and display the measurement.
5. When finished, press the **END** soft key.
6. To return to the METERS menu, press the **END** soft key.

Diode

This test measures the voltage drop across components, such as diodes.

1. Connect the probes test lead to the EXP's accessories port.
2. Select the meter's icon.
3. Connect the probes in the correct polarity: red clamp or probe to positive (+); black to negative (–).
4. The meter will autorange and display the measurement.
5. When finished, press the **END** soft key.

Volts/Amp (requires the optional amp clamp)

The volts/amp meter simultaneously measures charging voltage and charging current.

1. Connect the amp clamp lead to the EXP's accessories port.
2. Select the meter's icon.
3. Select the amp clamp range.
 - 1 70 AMP MAX.
 - 2 700 AMP MAX.Press the **NEXT** soft key to continue.
4. The meter will zero itself and display the amperage and voltage measurements.
5. Place the clamp's jaws around the negative (-) cable.
6. Connect the battery test cable to the EXP.
7. Connect the battery test clamps in the correct polarity: red clamp or probe to positive (+); black to negative (-).
8. The EXP will display the measurement.
9. To return to the METERS menu, press the **END** soft key.

Table 5: EXP Multimeter Specifications

The accuracy specification is defined as $\pm (n\% \text{ reading} + [\text{count} * \text{resolution}])$ at 77 °F.

Vdc

Range	Resolution	Accuracy	Overload Protection
0–60 V	0.01 V	0.05% + 2	120 Vrms

Accuracies are specified from 2% to 100% of range.

Vac

Range	Resolution	Accuracy	Overload Protection
0–24 Vac rms	0.01 Vac	0.1% + 3	120 Vrms

Accuracies are specified from 2% to 100% of range.

Adc

Range	Resolution	Accuracy	Overload Protection
0–70 A	0.01 A	$\pm 3\%$ of reading $\pm 1A$	1000 Arms
0–700 A	0.1 A	$\pm 3\%$ of reading $\pm 1A$	1000 Arms

Accuracies are specified from 2% to 100% of range.

Aac

Range	Resolution	Accuracy	Overload Protection
0–70 A	0.01 A	$\pm 3\%$ of reading $\pm 1A$	1000 Arms
0–700 A	0.1A	$\pm 3\%$ of reading $\pm 1A$	1000 Arms

Accuracies are specified from 2% to 100% of range.

Ohm

Range	Resolution	Accuracy	Overload Protection
10 Ω –2 M Ω	1 Ω	2.0% + 4	120 Vrms

Continuity

Range	Resolution	Accuracy	Overload Protection
< 10 Ω	1 Ω	2.0% + 4	120 Vrms

Diode

Range	Resolution	Accuracy	Overload Protection
0–1.5 V	0.01 V	0.05% + 2	120 Vrms

Temperature

Range	Resolution	Accuracy	Overload Protection
-20–200 °F	1 °F	1.0% + 5	-----

Chapter 10: Utilities

The EXP's Utility Menu has 9 utilities that you can easily set up to customize your analyzer:

- Language (English, French or Spanish)
- Format (memory disk)
- Update (software)
- Clock (adjustments to date and time)
- Shop (create a contact information header on test results printouts)
- Display (contrast and backlight time adjustments)
- Coupon (turn off the coupon option on test results printouts)
- Edit Coupon (create a promotional coupon on test results printouts)

Each utility described in this section is listed in order by its icon title.

Clock

The CLOCK ADJUST utility has 4 settings. Use the **UP/DOWN ARROW** keys to highlight the setting you want to change.

MODE :	AM/PM
TIME :	9:07 PM
FORMAT :	MM/DD/YYYY
DATE :	6/17/2005

Mode

Use the **UP/DOWN ARROWS** to move the dot to the option button of your choice.

1. Select the 24-hour or AM/PM mode
1 24 HOUR
2 AM/PM
2. Press the **SAVE** soft key to save your setting or the **BACK** soft key to return to the CLOCK ADJUST screen without saving the changes.

Time

1. Use the **LEFT/RIGHT ARROWS** to highlight the hour, minutes, or AM or PM. To rapidly scroll, hold down an **ARROW** key.

9 : 19 PM

2. Press the **SAVE** soft key to save your setting or **BACK** to return to the CLOCK ADJUST screen.

Format

Use the **UP/DOWN ARROWS** or press the corresponding numerical key to move the dot to the option button of your choice or enter its number.

1. Select the 24-hour or AM/PM mode
 - 1 MM/DD/YYYY (month/date/year)
 - 2 DD/MM/YYYY (date/month/year)
2. Press the **SAVE** soft key to save your setting or the **BACK** soft key to return to the CLOCK ADJUST screen without saving the changes.

Date

1. Use the **LEFT/RIGHT ARROWS** to highlight the hour, minutes, or AM or PM. To rapidly scroll, hold down an **ARROW** key.

6 / 17 / 2005

2. Press the **SAVE** soft key to save your setting or the **BACK** soft key to return to the CLOCK ADJUST screen without saving the changes.

Shop

The SHOP INFO utility enables you to create a header for your printed test results showing your business location information. Its two information screens contain eight lines of text with up to 16 characters on each line.

Screen 1

1-YOUR SHOP NAME _
2-1000 ANY STREET
3-YOUR TOWN, STATE
4-YOUR POSTAL CODE

Blinking cursor
shows the starting
location for editing

Screen 2

5-YOUR COUNTRY _
6-YOUR PHONE NUMBER
7-WWW.WEBSITE.COM
8-YOUR SHOP ID NUMBER

To create or overwrite a header:

1. Press the **UP** or **DOWN ARROW** to highlight the line you want to change. The cursor will be blinking to the right of the last character in the line.
2. To move the cursor backward to erase a character, press the **LEFT ARROW** key; to move the cursor forward, press the **RIGHT ARROW** key.
3. Insert a character by pressing the key associated with the character as many times as needed.
4. You can center text by selecting blank spaces before and after lines of text or insert spaces between words.
5. Press the **SAVE** soft key to save your setting or the **BACK** soft key to return to the SHOP INFO screen without saving the changes.

Display

The LCD OPTIONS utility enables you to adjust the contrast of the text on the display and the backlight time.

Contrast Level

The contrast level is 0 (lightest) to 10 (darkest). To change it:

1. Press the **UP** or **DOWN ARROW** to highlight the option.



2. Press the **ADJUST** soft key to display the option's numerical scroll box.



3. Press the **UP/DOWN ARROW** keys or the corresponding numerical key to select your preference.
4. Press the **SAVE** soft key to save your setting or the **BACK** soft key to return to the CONTRAST LEVEL screen without saving the changes.

Backlight Time

Backlight time is from 0 to 60 seconds. To change it:

1. Press the **UP** or **DOWN ARROW** to highlight the option.

CONTRAST LEVEL	10	
BACKLIGHT TIME	60	← Current settings

2. Press the **ADJUST** soft key to display the option's numerical scroll box.

60	◆	SEC
----	---	-----

3. Press the **UP/DOWN ARROW** keys or the corresponding numerical key to select your preference.
4. Press the **SAVE** soft key to save your setting or the **BACK** soft key to return to the BACKLIGHT screen without saving the changes.

Coupon

The COUPON SELECT utility enables and disables the printing of the custom coupon you've created in the EDIT COUPON utility.

1. Use the **UP/DOWN ARROWS** or press the corresponding numerical key to move the dot to the option button of your choice.
1 NO USER COUPON PRINTED
2 USER COUPON
2. Press the **SAVE** soft key to save your setting or the **BACK** soft key to return to the COUPON SELECT screen without saving the changes.

Edit Coupon

The EDIT COUPON utility enables you to create a promotional coupon for your customers that prints at the bottom of every test result. Its two information screens contain eight lines of text with up to 16 characters each.

The editing process is the same as when you create a header for your test results printouts. See the SHOP utility for more information.

Temp

The TEMP. UNITS utility enables you to set the units of measure to either Celsius or Fahrenheit.

To set your preference:

1. Use the **UP/DOWN ARROWS** or press the corresponding numerical key to move the dot to the option button of your choice.
 - 1 DEGREES F
 - 2 DEGREES C
2. Press the **SAVE** soft key to save your setting.

Language

The LANGUAGE utility enables you to select a language for the display and printouts. To set your preference:

1. Use the **UP/DOWN ARROWS** or press the corresponding numerical key to move the dot to the option button of your choice.
 - 1 ENGLISH
 - 2 ESPAÑOL
 - 3 FRANÇAIS
2. Press the **SAVE** soft key to save your setting.

Format Disk

Select this utility to format an SD card to receive data or erase all data on the card. The EXP will warn you before formatting the disk and ask you if you want to continue.

Update

As software updates become available you'll be able to use this utility to update the EXP software using files on an SD card.

Chapter 11: Info Menu

The Info Menu has 3 utilities to help you manage your test data and track the usage and history of your analyzer.

Totals

The TOTALS report displays the total number of battery tests performed since the EXP was first used. Press the **LEFT** and **RIGHT ARROW** keys simultaneously to clear the total and reset the starting date.

Transfer

The TRANSFER utility lets you transfer test data to a PC using an optional IR receiver/software package.

Version

Version displays the EXP's software version, the date the software was released, and the serial number of the analyzer. The utility keeps a permanent count of the number of battery tests performed since the analyzer was first used.

Chapter 12: Print/View

The Print/View Menu enables you to view and print the results of the Battery, System, and Cable Drop Tests before you perform another test and overwrite the results in memory.

View Test

VIEW TEST gives you the option of viewing and printing the results of the Battery and System Tests. To print the results, align the analyzer's IR transmitter with the printer's receiver, and select the **PRINT** soft key. To return to the Main Menu, press the **END** key.

View Cable Test

VIEW TEST gives you the option of viewing and printing the results of the Cable Drop Test. To print the results, align the analyzer's IR transmitter with the printer's receiver, and select the **PRINT** soft key. To return to the Main Menu, press the **END** key.

Chapter 13: Troubleshooting

If you have problems with the display or the Midtronics printer, try these troubleshooting suggestions:

The Display Does Not Turn On

- Check the connection to the vehicle battery.
- Press the **POWER** button.
- The vehicle's battery may be too low to power the analyzer (below 1 volt). Fully charge the battery and retest.
- The analyzer's 6 AA batteries may need to be replaced. Follow the directions in *Chapter 14: EXP Internal Batteries* and replace the batteries (alkaline recommended).
- If troubleshooting does not solve the problem, contact Midtronics at 1-800-776-1995 to obtain service. See "Patents, Limited Warranty, Service" for more information.

The STATUS LED Flashes (Midtronics Printer)

When a printer fault occurs, the **STATUS** LED flashes. You can identify the fault by the number of sequential flashes:

Table 6: Printer STATUS LED

Sequence	Condition	Solution
* * *	No paper	Insert new paper
** ** *	Thermal head too hot	Allow head to cool
*** ** *	Batteries weak	Recharge printer batteries for 16 hours

Data Will Not Print

- If the IR transmitter and receiver are not aligned, all the data may not print. The infrared ports on the top of the analyzer and on the printer below the **MODE** button should be pointed directly at each other. The maximum distance for reliable transmission between the ports is 17 in (45 cm).

To realign, press the **END** button to cancel the print job. Verify alignment between the analyzer and printer; then try to print the test results again.

- Make sure the printer is on. The printer shuts off after 2 minutes of inactivity to conserve the batteries. To turn the printer on, briefly press the **MODE** button. The green **STATUS** light should turn on. Make sure you are using the Midtronics printer. Other printers may not be compatible.

- Direct sunlight interferes with infrared data transmission and receiving. If the printer is not receiving data, remove the printer and EXP from direct sunlight. If the printed characters are not clear or are partially missing, recharge the battery and reprint.
- If you are unable to print after ensuring the analyzer is functioning, the printer is on, the batteries are good, and the IR transmitter and receiver are aligned, check the printer manual for further instructions or call Midtronics at 800-776-1995 for assistance. (See “Patents, Limited Warranty, Service” for more information.)

Chapter 14: EXP Internal Batteries

The EXP uses 6 AA, 1.5-volt batteries (alkaline recommended) to allow testing of batteries down to 1 volt and supply power while the menu is active. The analyzer can test batteries down to 5.5 volts when the internal batteries are not functioning.

Battery Power Indicator

The square in the upper left corner of the display indicates the charge level of the battery pack. The square is black when the battery pack is fully charged. It gradually changes to white as the charge level declines. The EXP will display a warning message when the batteries need replacing.

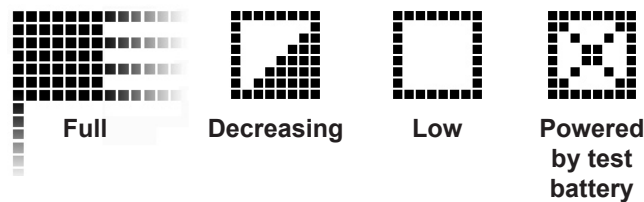

Figure 7: Power Level Indicator for EXP AA Batteries

Replacing the EXP Batteries

1. Turn the EXP face down.
2. Press gently on the ridges above the arrow on the battery compartment cover.
3. Slide the cover in the direction of the arrow and remove the cover.
4. Remove the discharged batteries.
5. Insert new batteries as shown in *Figure 22*. Make sure the positive and negative terminals are positioned correctly.
6. Insert the door's tabs into the slots on the analyzer and slide the door closed, making sure the latch locks.

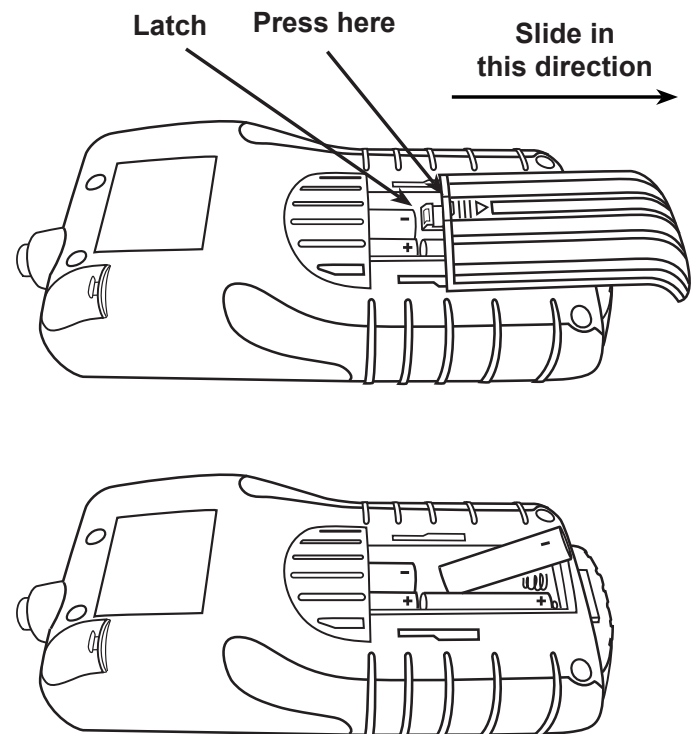

Figure 22: EXP Battery Replacement

PATENTS

The inTELLECT™ EXP Expandable Electrical Diagnostic Platform is made in the U.S.A. by Midtronics, Inc. and is protected by one or more of the following U.S. Patents: 4,816,768; 4,825,170; 4,881,038; 4,912,416; 5,572,136; 5,585,728; 5,592,093; 5,757,192; 5,821,756; 5,831,435; 5,914,605; 6,051,976; 6,091,245; 6,163,156; 6,249,124; 6,304,087; 6,310,481; 6,316,914; 6,323,650; 6,351,102; 6,359,441; 6,363,303; 6,392,414; 6,441,585; 6,445,158; 6,456,045; 6,469,511; 6,534,993; 6,544,078; 6,556,019; 6,566,883; 6,586,941; 6,707,303. Canadian Patents: 1,295,680; 1,280,164. United Kingdom Patent: 0,672,248; 0,417,173. German Patent: 693 25 388.6; 689 23 281.0-08; 93 21 638.6. And other U.S. and Foreign patents issued and pending. This product may utilize technology exclusively licensed to Midtronics, Inc. by Johnson Controls, Inc. and/or Motorola, Inc.

LIMITED WARRANTY

This analyzer is warranted to be free of defects in materials and workmanship for a period of one year from date of purchase. Midtronics will, at our option, repair or replace the unit with a remanufactured unit. This limited warranty applies only to the EXP analyzer, and does not cover any other equipment, static damage, water damage, overvoltage damage, dropping the unit, or damage resulting from extraneous causes including owner misuse. Midtronics is not liable for any incidental or consequential damages for breach of this warranty. The warranty is void if owner attempts to disassemble the unit or to modify the cable assembly.

SERVICE

To obtain service, contact Midtronics for a Return Authorization number, and return the unit to Midtronics freight prepaid, Attention: RA# _____. Midtronics will service the analyzer and reship the next scheduled business day following receipt, using the same type carrier and service as received. If Midtronics determines that the failure was caused by misuse, alteration, accident, or abnormal condition of operation or handling, purchaser will be billed for the repaired product and it will be returned freight prepaid with freight charges added to the invoice. Battery analyzers beyond the warranty period are subject to the repair charges in effect at that time. Optional remanufacturing service is available to return the tester to like-new condition. Out-of-warranty repairs will carry a 3-month warranty. Remanufactured units purchased from Midtronics are covered by a 6-month warranty.

**Midtronics, Inc.**

7000 Monroe Street
Willowbrook, IL 60527
U.S.A.

Tel.: 630.323.2800

Fax: 630.323.2844

ISO 9001 Certified

Midtronics Canada, Inc.

54 Ferris Drive
P.O. Box 746
North Bay, Ontario

P1B 8J8 Canada

Tel.: 705.476.9228

Fax: 705.476.9255

ISO 9001:2000 Certified

Midtronics bv

Lage Dijk-Noord 6
3401 VA IJsselstein
The Netherlands

Tel.: +31 306 868 150

Fax: +31 306 868 158

ISO 9001:2000 Certified



www.midtronics.com

Toll-free in North America: 1-800-776-1995