

CLEGHORN WARING



Choosing and installing a

WATER STORAGE HEATER

(CALORIFIER)
for your boat

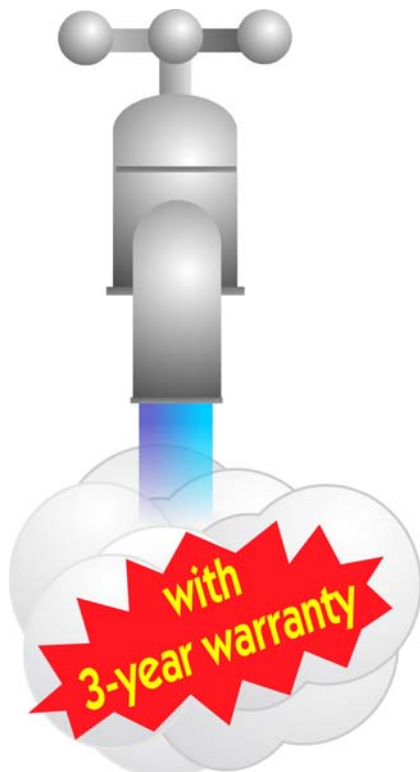



WATER STORAGE HEATERS (CALORIFIERS)

from **CLEGHORN
WARING**

*Four ranges
to meet every requirement*

When you buy a **C-WARM** or **SEAWARD** heater, you are choosing quality with no compromises.

- Top-grade copper and aluminium pressure tanks. Useful amounts of hot water from engine waste heat almost before you've begun to think about it.
- Efficient, 100% ozone-friendly foam insulation keeps the water hot for hours. Clean, silent, and maintenance free, C-WARM and SEAWARD heaters offer you options to suit every boat and budget.
- C-WARM and SEAWARD heaters come with a **3-year warranty** backed by Cleghorn Waring's 20 years of specialist experience in pressurised water systems. Think systematically - choose C-WARM or SEAWARD

Your guide to systematic heater selection is set out in the pages that follow

Cleghorn Waring
Icknield Way
Letchworth Garden City
Herts
SG6 1EZ • UK

tel: +44(0)1462 480380
fax: +44(0)1462 482422
mail@cleghorn.co.uk
www.cleghorn.co.uk

C-WARM COMPACT

- Pre-assembled, ready to fit and use
- 4 models in popular sizes

C-WARM COMPACT major

- Pre-assembled, ready to fit and use
- 3 models in larger popular sizes

SEAWARD COMPACT

- Pre-assembled, ready to fit and use
- 3 models in popular sizes

C-WARM MODULAR

- For every shape and size of boat
- More than 30 models
- Choice of mounting brackets & straps, immersion heaters, single/twin coil, thermostatic controls



SAFETY
Don't cut corners



C-WARM and SEAWARD heaters are fitted with **two independent safety systems** to prevent overheating if an immersion heater thermostat should fail. These are required by UK law for unvented pressure systems in houses. Although (at the time of writing) boats are exempt, this is a common sense precaution that should not be overlooked. A combined **temperature-and-pressure relief valve** comes with every C-WARM and SEAWARD heater, together with **twin immersion heater thermostats**.

Don't settle for less.

SCHEMATIC DIAGRAM of a PRESSURISED WATER SYSTEM

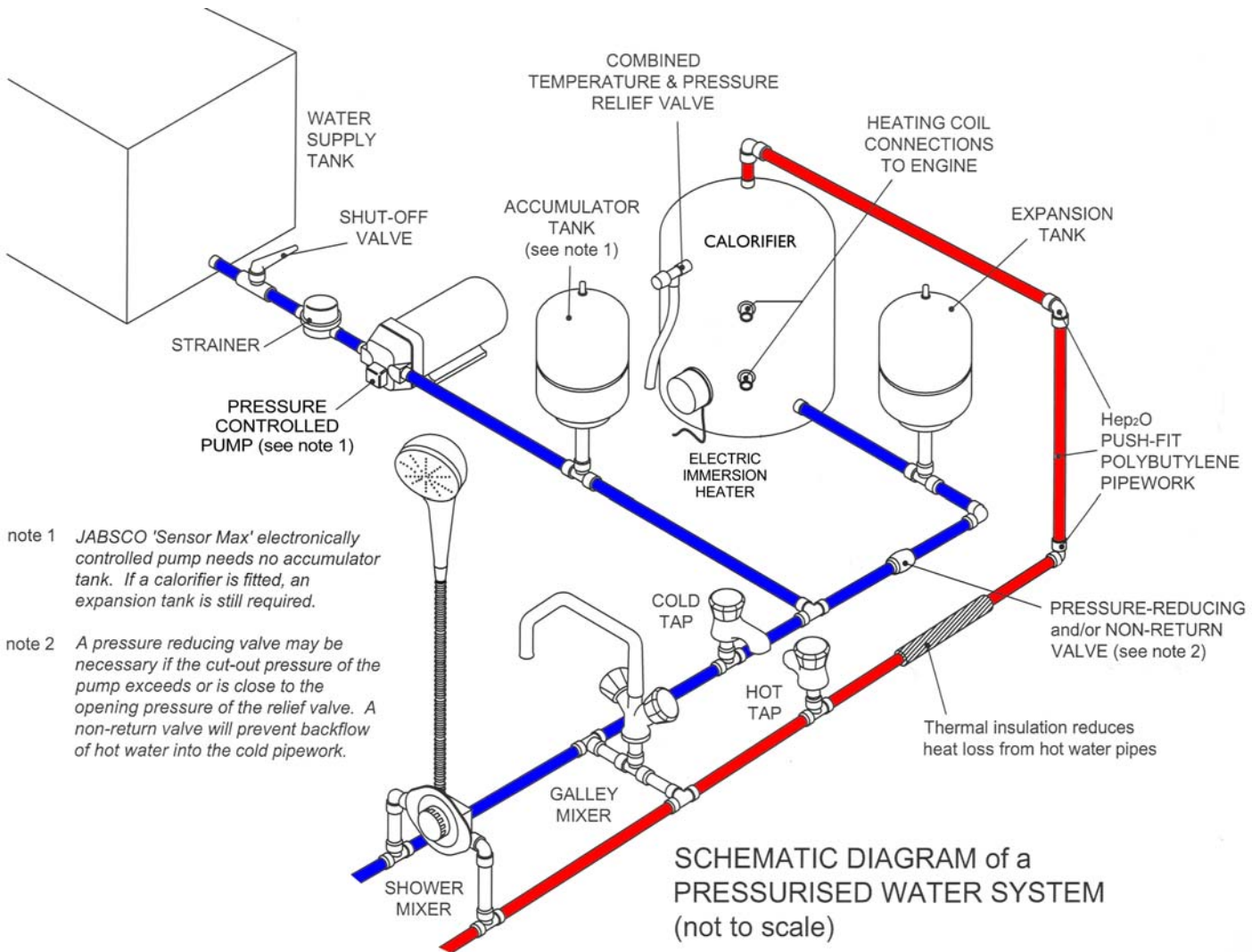

HOW A CALORIFIER WORKS

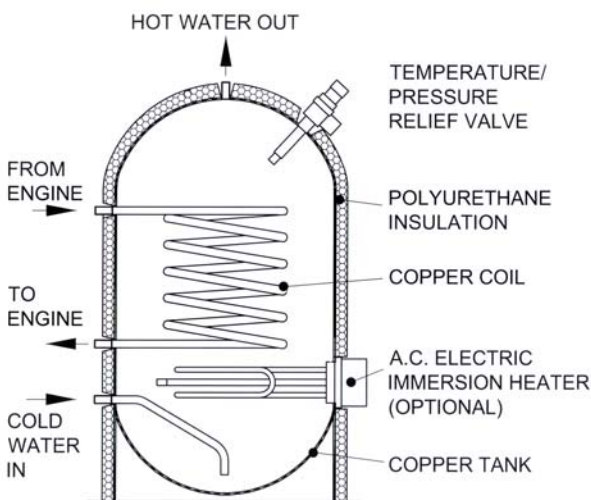

Hot water from the engine cooling circuit enters the helical coil at the top. As it flows down through the coil, it gives up heat to the stored water in the tank, and returns at a lower temperature to the engine cooling circuit.

As the stored water heats up it rises by convection. Hot water is drawn off through the top outlet: cold water flows in at the bottom of the tank to replace it. If mains voltage a.c. electricity is available, an electric immersion heater may be fitted for use when the engine is not running.

Calorifiers and Water Storage Heaters – what's the difference?

None. 'Calorifier' is a word borrowed from industrial process heating, meaning a water vessel containing a heat exchanger (such as a coiled pipe) through which steam or hot water passes, giving up its heat to the water contained in the vessel.

WHAT SIZE WATER STORAGE HEATER DO I NEED?

Most boat owners choose to store as much hot water as they can in the space available.

10-15 litres of water at 50°C is sufficient for a refreshing hot shower. With limited fresh water supplies on board, less than 10 litres is often enough. The water consumption of a shower depends more on shower head design than on water pressure. Cleghorn Waring offer a range of shower heads designed for marine use, compatible with C-WARM and SEAWARD calorifiers and with water pressure systems in boats

NO OF PERSONS ABOARD*	WATER STORAGE HEATER CAPACITY LITRES (GALLONS)	LENGTH OF VESSEL METRES (FEET)
1	18 - 20 (4)	7.5 - 10 (25 - 33)
2 - 3	20 - 55 (4 - 12)	10 - 12.5 (33 - 40)
4 - 5	55 - 74 (12 - 16)	12.5 - 15 (40 - 50)
5+	74 - 141 (16 - 31)	15 - 18 (50 - 60)

This table is intended as a rough guide to selection. Besides the space available, personal preference and cost may also influence the choice.

*requiring consecutive hot showers, 10 litres per shower

SPACE AVAILABLE

Check the space available, preferably close to the engine. Is there room to locate, support and secure the heater and connect the pipework? Is there room to fit or remove an electric immersion heater if necessary?

Vertical tanks are thermally a little more efficient, but a horizontal tank can sometimes make better use of available space.

Allow at least an extra 50mm for all pipework connections.

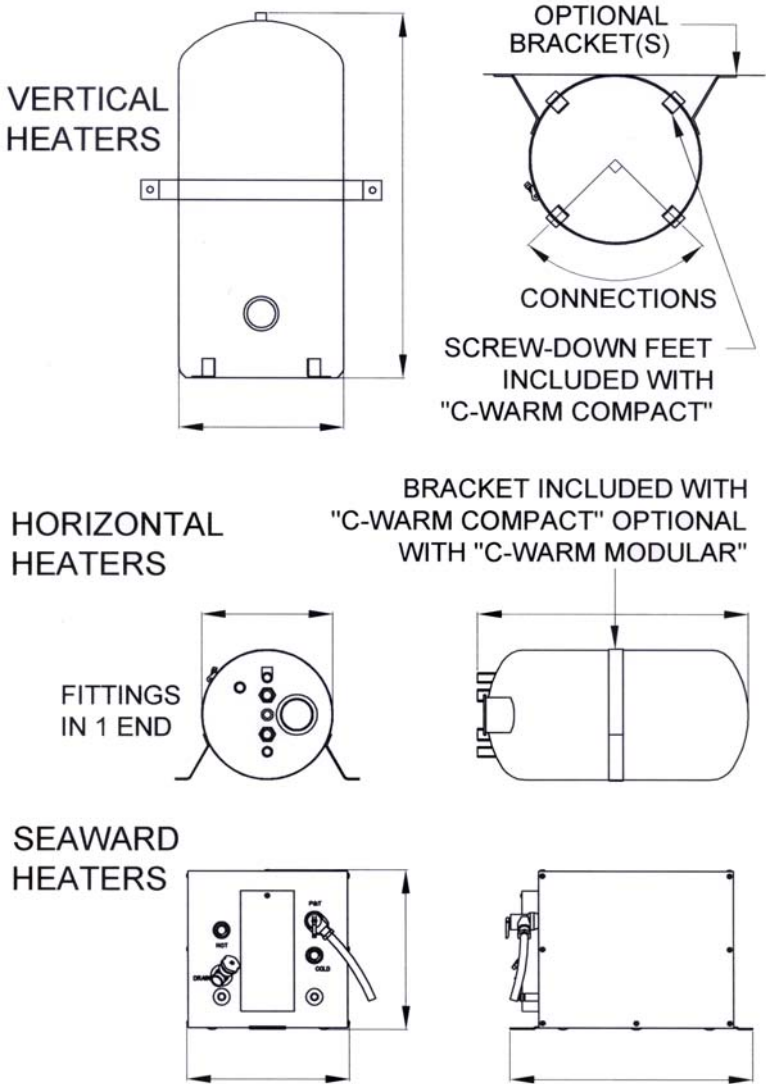

SELECTION CHART

C-WARM COMPACT RANGE

MODEL ¹ H = horizontal V = vertical	TYPE			DIMENSIONS ² , mm			WEIGHT ² , kg		CONNECTIONS ³	
	CAPACITY		No of coils						heating coil hose	cold in - hot out
	litres	gallons		length	diameter	full	empty			
CWC18-H3	18	4	1	625	x	275	26	8	½"	½"BSP EXT.
CWC20-V3	20	4.4	1	380	x	355	29	9	½"	½"BSP INT.
CWC29-V3	29	6	1	445	x	38	39	10	½"	½"BSP EXT.
CWC40-V3	40	9	1	405	x	455	53	13	½"	½"BSP INT.

C-WARM COMPACT Major RANGE

MODEL ¹ H = horizontal V = vertical T = twin coil	TYPE			DIMENSIONS ² , mm			WEIGHT ² , kg		CONNECTIONS ³	
	CAPACITY		No of coils						heating coil hose	cold in - hot out
	litres	gallons		length	diameter	full	empty			
CWC53-VT3	53	12	2	720	x	400	74	21	½"	½"BSP EXT.
CWC64-HT3	64	14	2	685	x	450	81	17	½"	¾"BSP INT.
CWC73-HT3	73	16	2	758	x	450	91	18	½"	¾"BSP INT.

SEAWARD COMPACT RANGE

MODEL H = horizontal V = vertical	TYPE			DIMENSIONS, mm			WEIGHT ² , kg		CONNECTIONS	
	CAPACITY		No of coils						heating coil hose	cold in - hot out
	litres	gallons		wide	deep	high	full	empty		
CWC-F650W	25	5	1	330	490	330	37	11.5	5/8"	15mm Hep2o
CWC-F1150W	42	9	1	406	558	406	56	13.6	5/8"	15mm Hep2o
CWC-F1850W	68	15	1	514	514	685	89.5	21.5	5/8"	15mm Hep2o

¹Standard models listed here are uncased, with a rated pressure of 3 bar (44 p.s.i.).

Cased models are available. Contact our Sales Office for details

²The dimensions and weights listed here are approximate. For critical dimensions ask for a drawing.

³Immersion heater connection is 2¼" BSP (internal) on all models.

SELECTION CHART

C-WARM MODULAR RANGE

MODEL ¹ H = horizontal V = vertical T = twin coil	TYPE			DIMENSIONS ² , mm		WEIGHT ² , kg		CONNECTIONS ³	
	CAPACITY		No of coils	*allow at least 75mm under the heater, for pipe fittings		full	empty	heating coil BSP internal	cold in hot out BSP I= Internal E= External
	litres	gallons		length	diameter				
CWB18-H3	18	4	1	565	x 275	26	8	½"	½" E
CWB21-V3	20	4.4	1	380	x 355	29	9	½"	½" I
CWB29-V3	29	6	1	445	x 380	39	10	½"	½" E
CWB29-VT3	29	6	2	445	x 380	40	11	½"	½" E
CWB32-H3	32	8	1	900	x 275	45	13	½"	½" E
CWB40-V3	40	9	1	405	x 455	51	11	½"	½" I
CWB41-H3	40	9	1	585	x 380	50	10	½"	½" I
CWB41-HT3	40	9	2	585	x 380	51	11	½"	½" I
CWB45-H3	45	10	1	1215	x 275	62	17	½"	½" E
CWB50-V3	50	12	1	440	x 490	69	19	½"	½" E
CWB50-VT3	50	12	2	440	x 490	70	20	½"	½" E
CWB50-H3	50	12	1	685	x 400	70	17	½"	½" E
CWB50-HT3	50	12	2	685	x 400	72	19	½"	½" E
CWB53-H3	53	12	1	785	x 380	74	21	½"	½" E
CWB53-HT3	53	12	2	785	x 380	76	23	½"	½" E
CWB53-V3	53	12	1	720	x 400	71	18	½"	½" E
CWB53-VT3	53	12	2	720	x 400	73	20	½"	½" E
CWB64-H3	67	14	1	610	x 450	78	14	½"	¾" I
CWB64-HT3	67	14	2	610	x 450	80	16	½"	¾" I
CWB67-V3	67	15	1	705	x 450	88	21	½"	¾" E
CWB67-VT3	67	15	2	705	x 450	90	23	½"	¾" E
CWB73-H3	73	16	1	685	x 450	88	15	½"	¾" I
CWB73-HT3	73	16	2	685	x 450	90	17	½"	¾" I
CWB78-V3	78	16	1	630	x 500	101	23	½"	¾" E
CWB78VT3	78	16	2	630	x 500	103	25	½"	¾" E
CWB93-V3	93	21	1	930	x 450	118	25	½"	¾" E
CWB93-VT3	93	21	2	930	x 450	120	27	½"	¾" E
CWB141-V3	141	30	1	1080	x 500	179	38	½"	¾" E
CWB141-VT3	141	30	2	1080	x 500	181	40	½"	¾" E

¹ Standard models listed here are uncased, with a rated pressure of 3 bar (44 p.s.i.).

Cased models are available. Contact our Sales Office for details

² The dimensions and weights listed here are approximate. For critical dimensions ask for a drawing.

³ Immersion heater connection is 2¼" BSP (internal) on all models.

SHAPES

C-WARM COMPACT

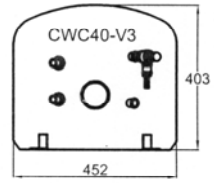
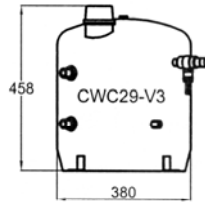
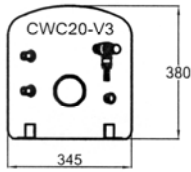
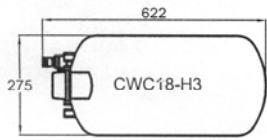

C-WARM COMPACT MAJOR

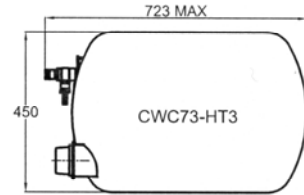
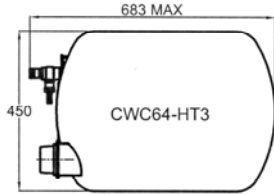
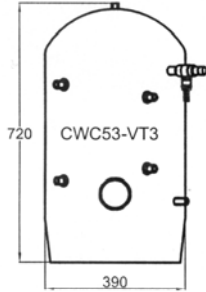

SEAWARD COMPACT

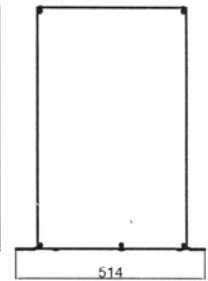
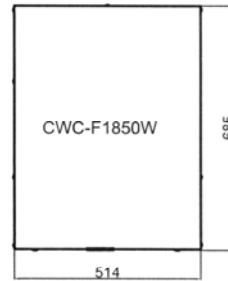
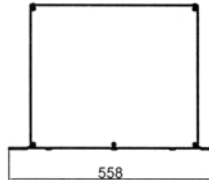
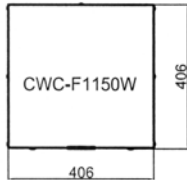
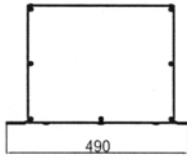
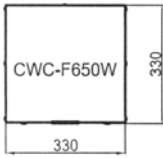

C-WARM MODULAR

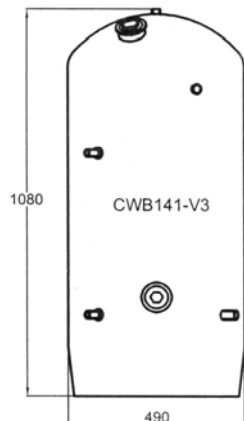
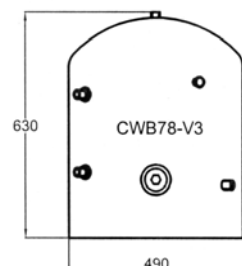
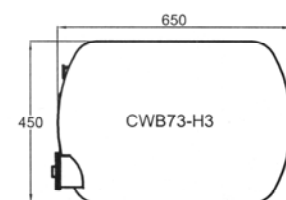
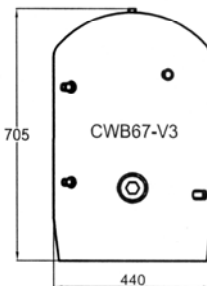
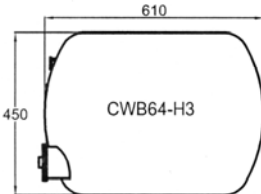
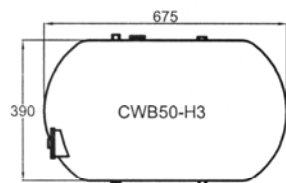
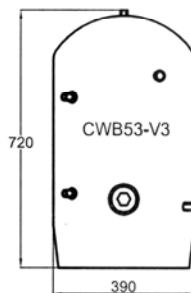
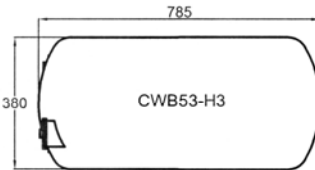
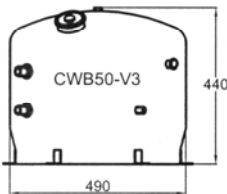
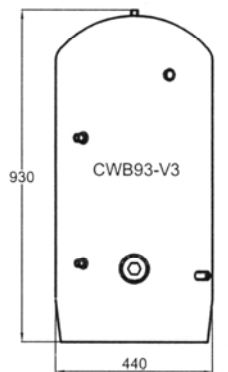
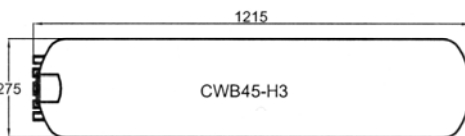
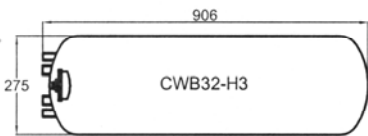
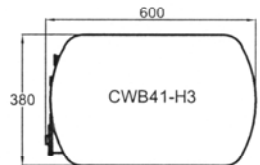
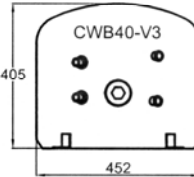
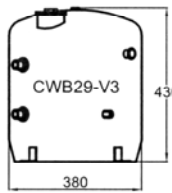
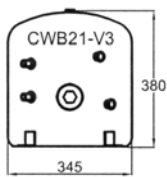
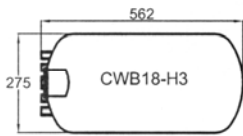

SINGLE OR TWIN COIL?

Choose a single coil model unless you plan to utilise waste heat from more than one engine, or to install an auxiliary burner to heat the water when the engine is not running.

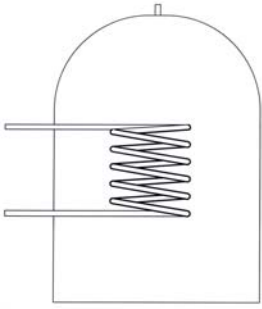

SINGLE COIL

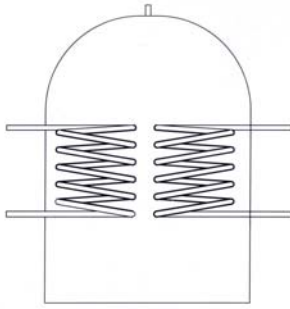

TWIN COIL

WATER PRESSURE

C-WARM and SEAWARD heaters are pressure vessels, designed for use at specified maximum internal pressures. Check the cut-out pressure of the pump: it must not exceed the rated pressure of the heater. If it does, you will need to fit a pressure-reducing valve in the inlet line to the heater - see diagram on page 1.

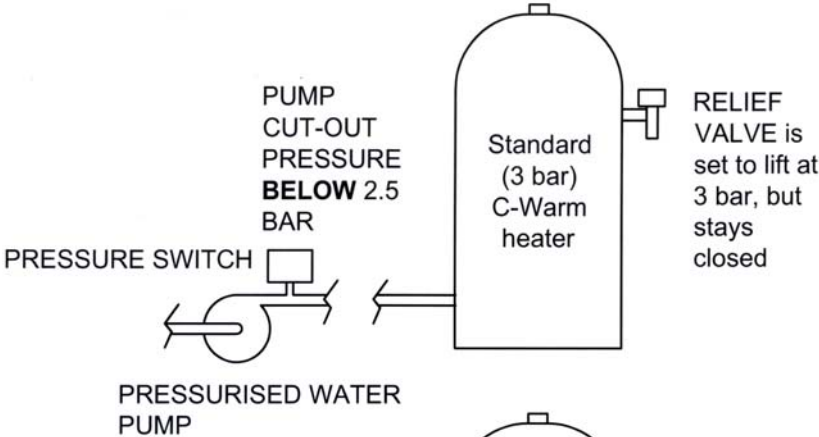

The heater is protected against excessive pressure by a relief valve. Combined temperature-and-pressure relief valves are standard on C-WARM and SEAWARD heaters. (See safety note on page 14)

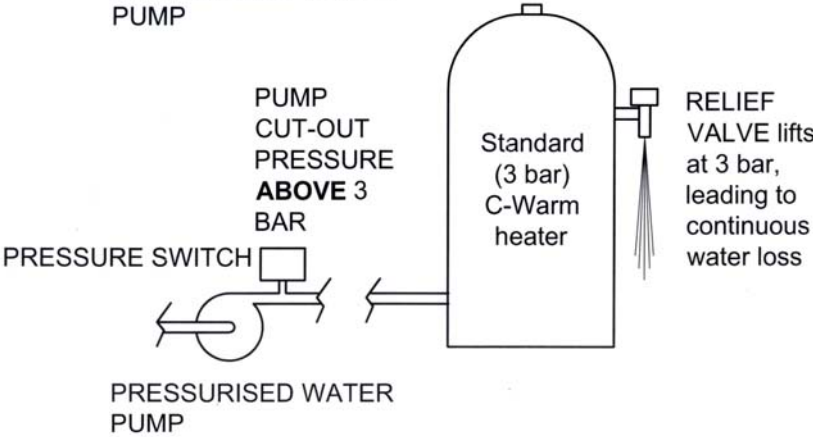

<i>Pump cut-out pressure</i>	<i>Rated pressure of heater</i>	<i>Relief valve opening pressure</i>	<i>Suitable heaters</i>
Less than 2.5 bar (36 psi)	3 bar (44 psi)	3 bar (44 psi)	C-WARM SEAWARD
Up to 4.5 bar (66 psi)	5 bar (73 psi)	5 bar (73 psi)	SEAWARD

THERMAL EXPANSION

Water expands as its temperature rises. In a system fitted with an accumulator tank, warm water may find its way back into the cold water line during heating. This effect can be minimised or avoided by:

1. Allowing at least 0.5 bar difference between pump cut-out pressure and relief valve opening pressure **and**
2. Fitting a non-return valve and expansion tank in the cold inlet line to the heater to minimise the pressure rise due to thermal expansion

If a pressure reducing valve is fitted to reduce the pressure from the pump (see page 6), it will also act as a non-return valve.

NOTE: Jabsco 'Sensor-Max' pump

If you are using a Jabsco 'Sensor-Max' pump, no accumulator tank is required. But you will still need a non-return valve and expansion tank, as outlined above.

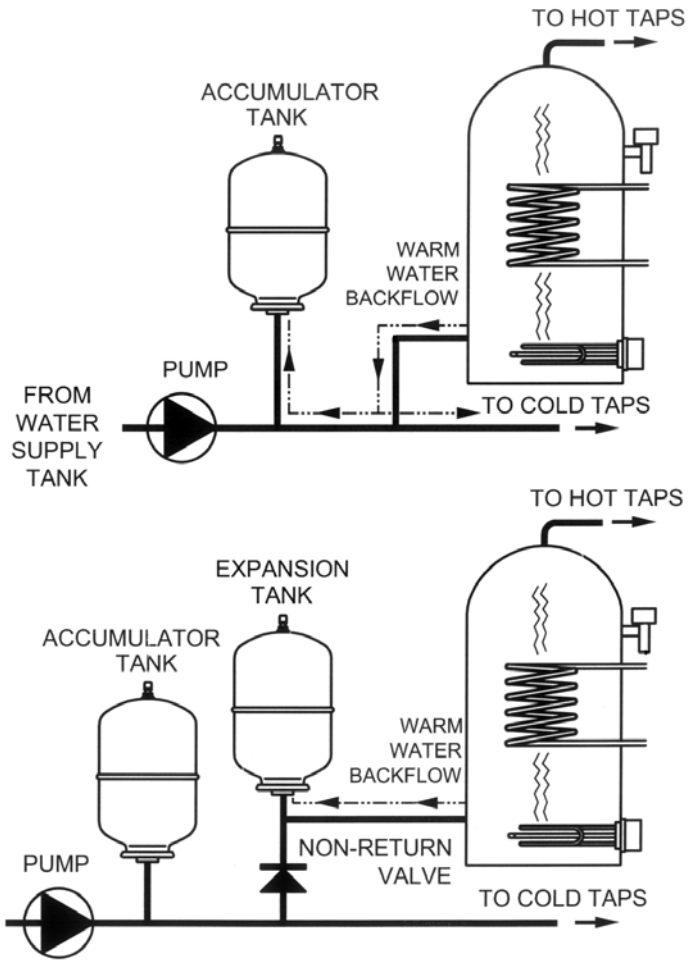

WHAT SIZE OF EXPANSION TANK DO I NEED?

1. Check the cut-out pressure of your pump
2. Determine the EXPANSION TANK VOLUME FACTOR from the table below

Cut-out pressure of pump	EXPANSION TANK VOLUME FACTOR	
	C-WARM heater	SEAWARD heater
up to 1.8 bar (25 psi)	15	26
2.0 bar (29 psi)	12	25
2.5 bar (37 psi)	6	21
2.8 bar (40 psi)	not applicable	18

Expansion tanks	
CW269	2 - litre
CW385	5 - litre
CW288	8 - litre
CW291	20 - litre

3. Divide the capacity of your heater (in litres) by the volume factor, to obtain the expansion tank volume you require.

EXAMPLE

A 64 litre C-WARM heater and a pump cut-out pressure of 1.8 bar

From the table, EXPANSION TANK VOLUME FACTOR = 15

Divide heater volume by EXPANSION TANK VOLUME FACTOR:-
 $64 \div 15 = 4.3 \text{ litres}$

Non-return valves	
CW91	½" BSP connections
CW92	¾" BSP connections

4. Use the next larger standard size of expansion tank, which is 5 litres (Model **CW385**)

HOW HOT WILL THE WATER BE?

Indirect-cooled engine

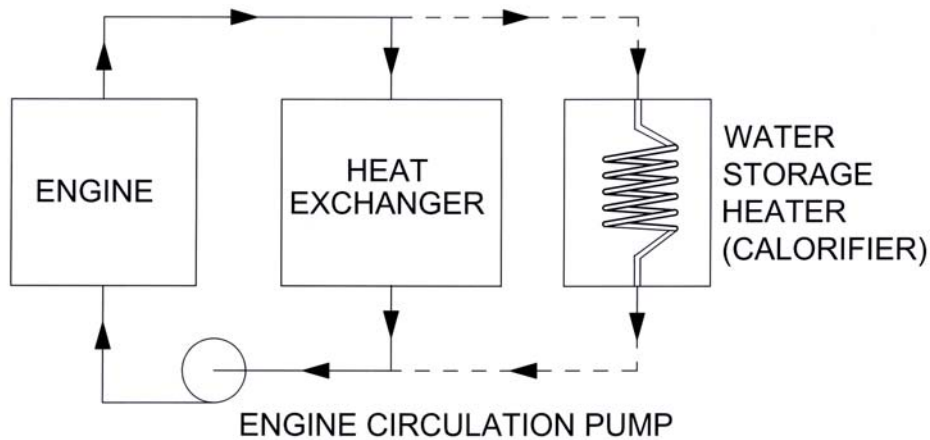

Cooling water circulates through the coil in the heater in parallel with the flow through the engine heat exchanger.

The temperature of the stored water can approach that of the very hot water in the engine cooling circuit. A BLENDER VALVE permits mixing of the stored hot water with cold water to achieve a selected temperature (typically 55°C). The amount of hot water available is effectively increased.

The temperature of water available at hot taps should not be allowed to exceed 65°C.

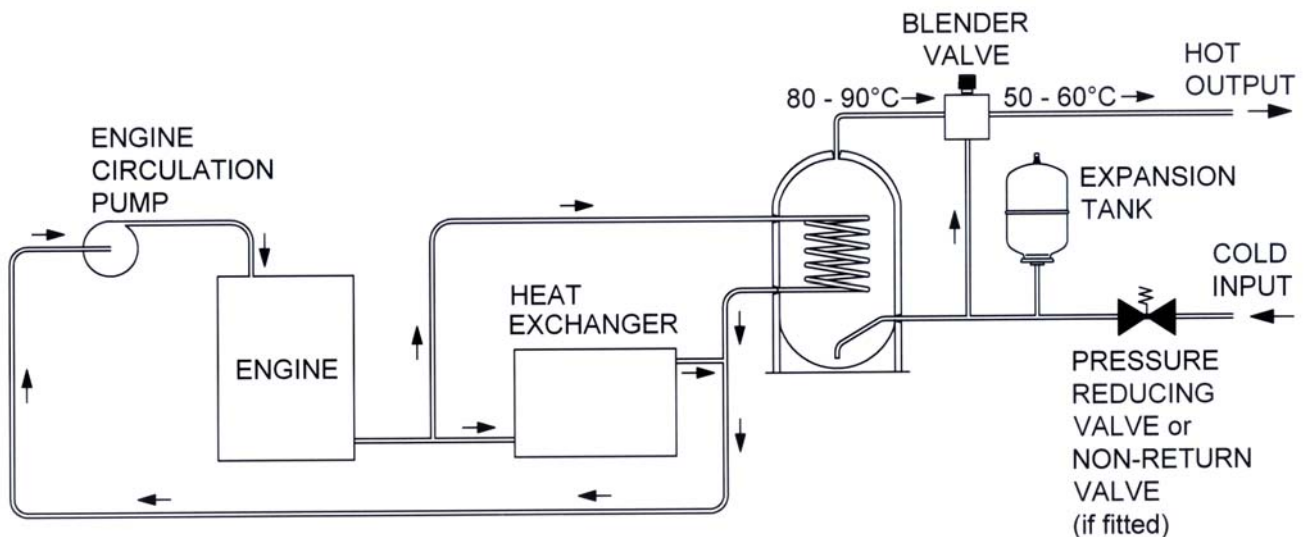

- Blender valve CW268* (½" BSP connections)
- Blender valve CW272B* (22mm compression joints)

Using a Pressure-Reducing valve in conjunction with a Blender valve

If a blender valve is to be fitted, its cold water inlet should be connected into pipework between the pressure-reducing valve and the cold inlet fitting on the heater (see diagram).

HOW HOT WILL THE WATER BE? ...continued

If the engine runs for a long enough time, it is possible for the stored water temperature to trip the immersion heater high level thermostat and/or open the temperature-and-pressure relief valve. A **CYLINDER THERMOSTAT** may be fitted to limit the water temperature in the heating coil

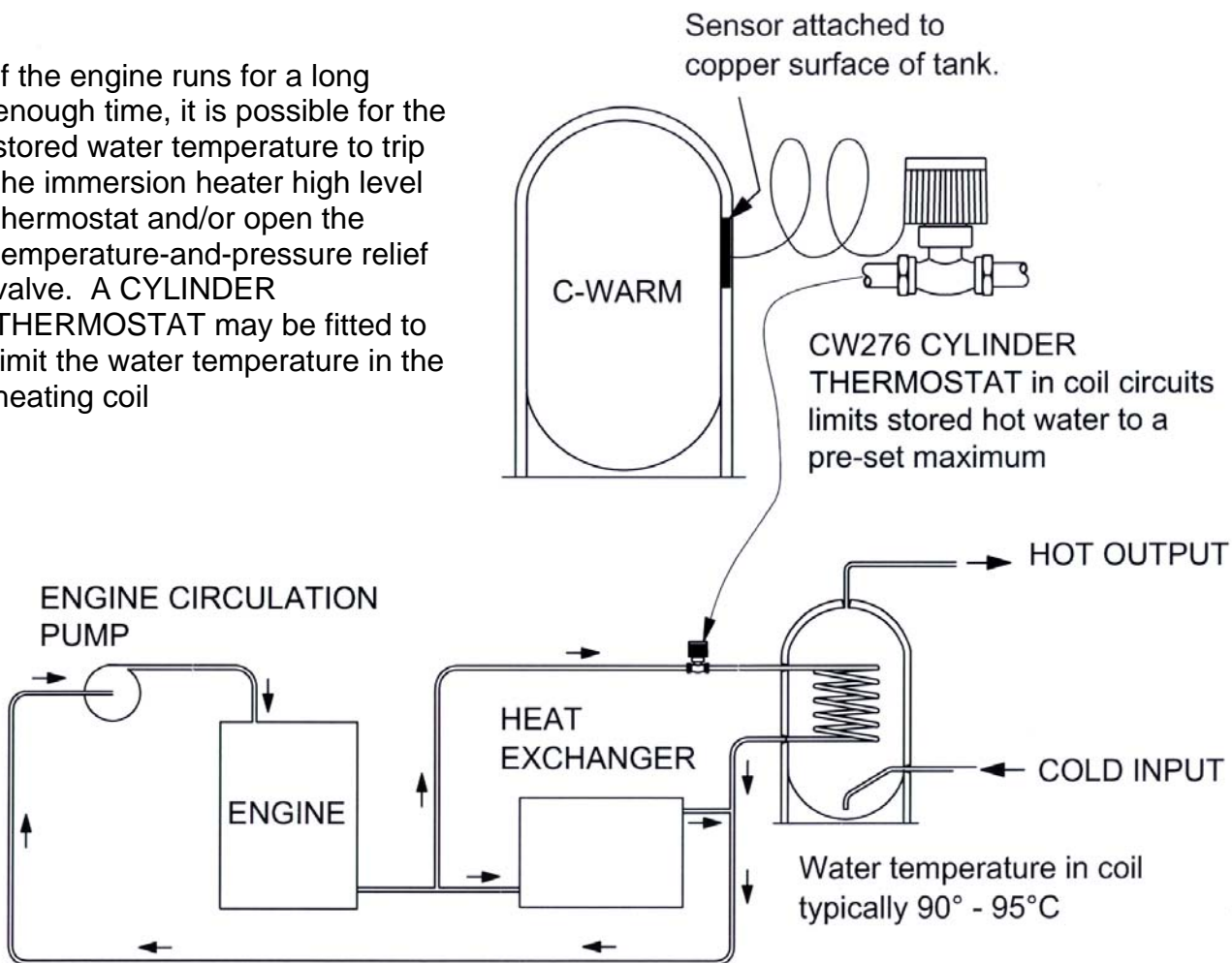

Direct-cooled engine

The temperature of the stored water heated by a direct-cooled engine is less predictable. Many engines are designed to run with a relatively high water temperature in the engine block, while the exhaust is cooled to a lower temperature. With suitable take-off and re-entry, an adequate stored water temperature can often be achieved.

Check your engine manual for details, or ask your engine supplier.

The instruction manual supplied with C-Warm explains how to adapt the engine cooling circuit to incorporate the storage heater.

Thermostatic control may not be necessary with direct-cooled engines.

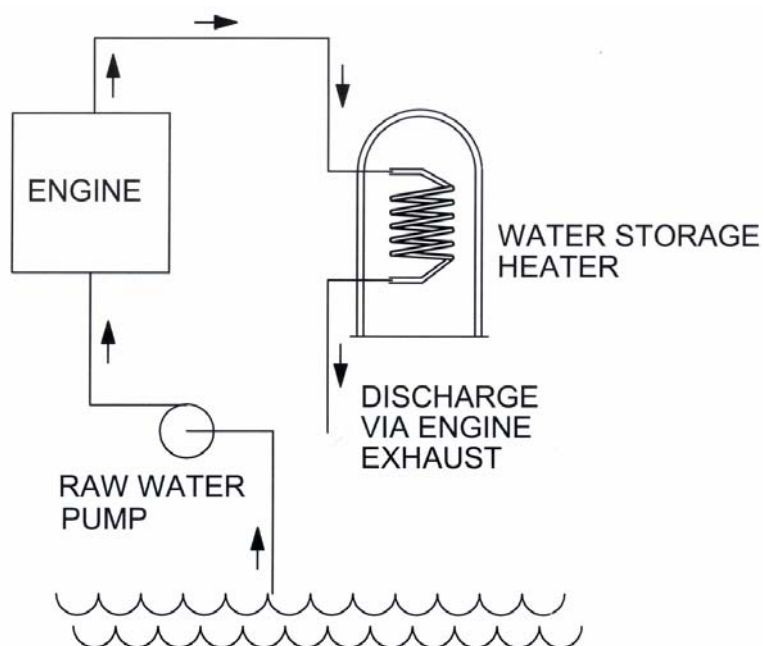

How long will the ENGINE take to heat the water?



C-WARM

C-WARM and SEAWARD heaters will produce useful amounts of hot water within about 20 minutes



SEAWARD

How long will an ELECTRIC IMMERSION heater take to heat the water?

Nominal time to heat a full tank of water from 10°C to 55°C. A usable amount of hot water will accumulate by convection in the top of the heater in less time than that shown.

Heater capacity litres	IMMERSION HEATER POWER					
	0.75 kW	1 kW	1.25 kW	1.5 kW	2 kW	3 kW
18	1 hr 15 min	58 min	45 min	37 min	29 min	19 min
20	1 hr 22 min	1 hr 03 min	50 min	41 min	31 min	21 min
25	1 hr 45 min	1 hr 18 min	1 hr 02 min	51 min	40 min	26 min
29	2 hr 02 min	1 hr 31 min	1 hr 12 min	1 hr 00 min	46 min	30 min
32	2 hr 14 min	1 hr 40 min	1 hr 20 min	1 hr 07 min	49 min	32 min
40	2 hr 45 min	2 hr 05 min	1 hr 40 min	1 hr 23 min	1 hr 03 min	42 min
45		2 hr 20 min	1 hr 53 min	1 hr 34 min	1 hr 12 min	47 min
50		2 hr 36 min	2 hr 05 min	1 hr 44 min	1 hr 18 min	53 min
53			2 hr 13 min	1 hr 50 min	1 hr 23 min	56 min
67			2 hr 48 min	2 hr 20 min	1 hr 47 min	1 hr 12 min
74				2 hr 34 min	1 hr 56 min	1 hr 18 min
78				2 hr 42 min	2 hr 03 min	1 hr 23 min
93					2 hr 26 min	1 hr 37 min
141						2 hr 28 min

EXAMPLE A 1.25 kW immersion heater will take about 1 hr 40 min to heat 40 litres of stored water from 10 to 55°C

HOW LONG WILL THE WATER STAY HOT?

Depending on heater volume and on ambient temperature, the stored water temperature will drop from a nominal 55°C to 35°C (still warm enough for a comfortable shower) over a period of about 8 - 20 hours after the engine has stopped. The larger the volume of the heater, the more slowly the stored water will cool.

SECURING THE HEATER IN PLACE

When full of water the heater is heavy. It must be secured in place to prevent damage to itself, its pipework and the supporting structure in rough weather or from other shocks of marine use.

C-WARM COMPACT models

The heater is supplied with fixings.

SEAWARD COMPACT

The heater is supplied with fixings.

C-WARM MODULAR and C-WARM COMPACT major

The best method of securing the heater will depend on its size, its shape and where it is to be located. Use Strap Kit or Bracket Kits (pages 12, 13) and/or construct suitable supports.

VERTICAL MODELS

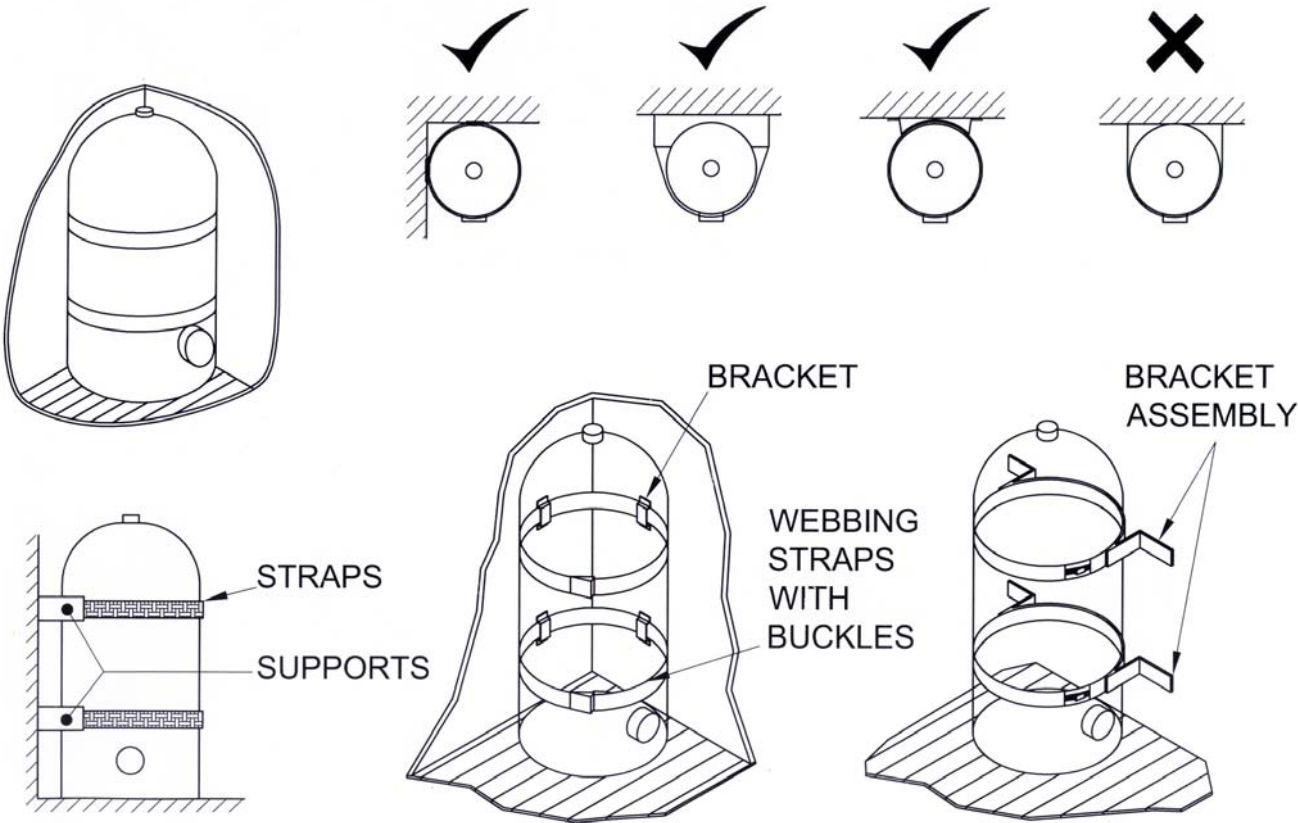

HORIZONTAL MODELS

If the heater has cold water and coil connections underneath, adequate clearance will need to be left for the pipe connections. See dimensions, pages 4 - 5.

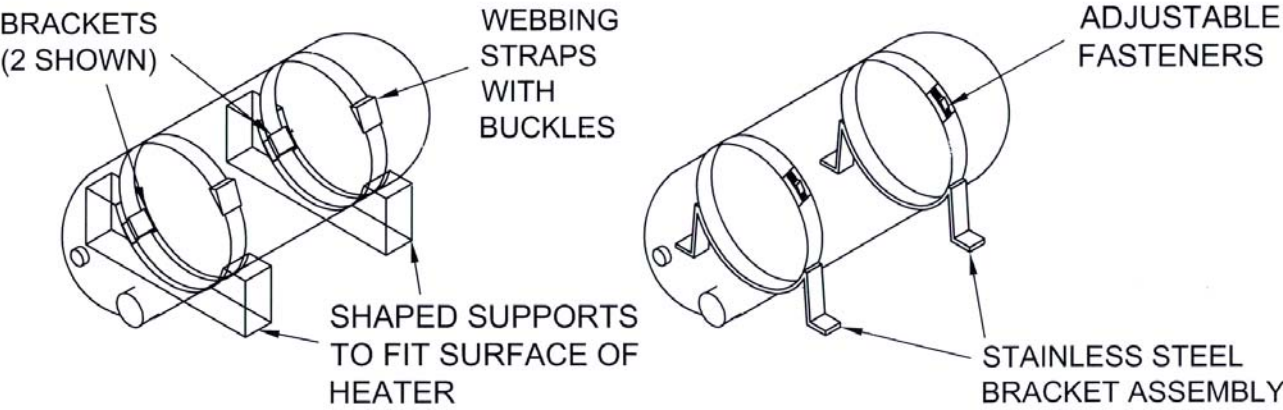
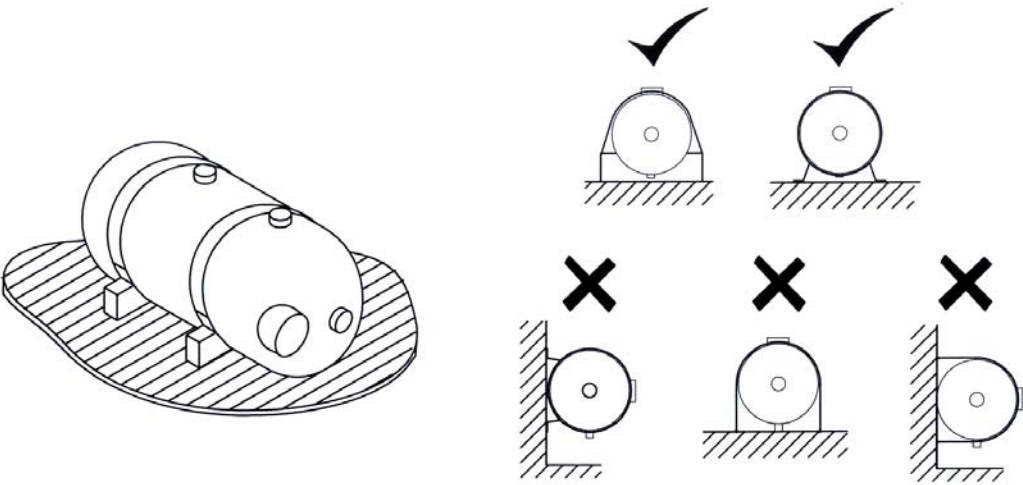

KIT SELECTION CHART

C-WARM MODULAR RANGE

MODEL¹ H = horizontal V = vertical T = twin coil	BRACKET KIT	CONNECTION KIT	
CWB18-H3	CWAB285H	CWB-CKIT-1	
CWB21-V3	CWAB350V	CWB-CKIT-3	
CWB29-V3	CWAB380V	CWB-CKIT-1	
CWB29-VT3	CWAB380V	CWB-CKIT-1T	
CWB32-H3	CWAB285H	CWB-CKIT-1	
CWB40-V3	CWAB440V	CWB-CKIT-3	
CWB41-H3	CWAB380H	CWB-CKIT-3	
CWB41-HT3	CWAB380H	CWB-CKIT-3T	
CWB45-H3	CWAB285H	CWB-CKIT-1	
CWB50-V3	CWAB490V	CWB-CKIT-1	
CWB50-VT3	CWAB490V	CWB-CKIT-1T	
CWB50-H3	CWAB380H	CWB-CKIT-1	
CWB50-HT3	CWAB380H	CWB-CKIT-1T	
CWB53-H3	CWAB380H	CWB-CKIT-1	
CWB53-HT3	CWAB380H	CWB-CKIT-1T	
CWB53-V3	CWAB380V	CWB-CKIT-1	
CWB53-VT3	CWAB380V	CWB-CKIT-1T	
CWB64-H3	CWAB440H	CWB-CKIT-4	
CWB64-HT3	CWAB440H	CWB-CKIT-4T	
CWB67-V3	CWAB440V	CWB-CKIT-2	
CWB67-VT3	CWAB440V	CWB-CKIT-2T	
CWB73-H3	CWAB440H	CWB-CKIT-4	
CWB73-HT3	CWAB440H	CWB-CKIT-4T	
CWB78-V3	CWAB490V	CWB-CKIT-2	
CWB78VT3	CWAB490V	CWB-CKIT-2T	
CWB93-V3	CWAB440V	CWB-CKIT-2	
CWB93-VT3	CWAB440V	CWB-CKIT-2T	
CWB141-V3	CWAB490V	CWB-CKIT-2	
CWB141-VT3	CWAB490V	CWB-CKIT-2T	

Connection kit contents:

- Hose connectors for heating coil (2 for single coil, 4 for twin coils)
- Hep₂O connectors for hot outlet and cold inlet (1 straight, 1 × 90°)
- Draincock and Hep₂O T-connector

ELECTRIC IMMERSION HEATERS: A SAFETY NOTE

The possible consequences of overheating need to be considered if an electric immersion heater is fitted to the calorifier. A thermostat controls the immersion heater. Immersion heaters fitted in C-WARM and SEAWARD calorifier have an additional high-temperature cut-out to prevent boiling if the control thermostat fails.

Because boiling water under pressure is dangerous, UK law requires unvented systems in houses to have **two independent means of protection** against overheating. Although boats are exempt (at the time of writing) this is a common-sense precaution that should not be ignored. To meet this requirement C-WARM and SEAWARD calorifiers are fitted with a combined **temperature-and-pressure relief valve** in addition to an immersion heater with a standard thermostat and a high-temperature cut-out.

A **pressure-relief** valve alone cannot prevent boiling under pressure, and does not provide sufficient protection.

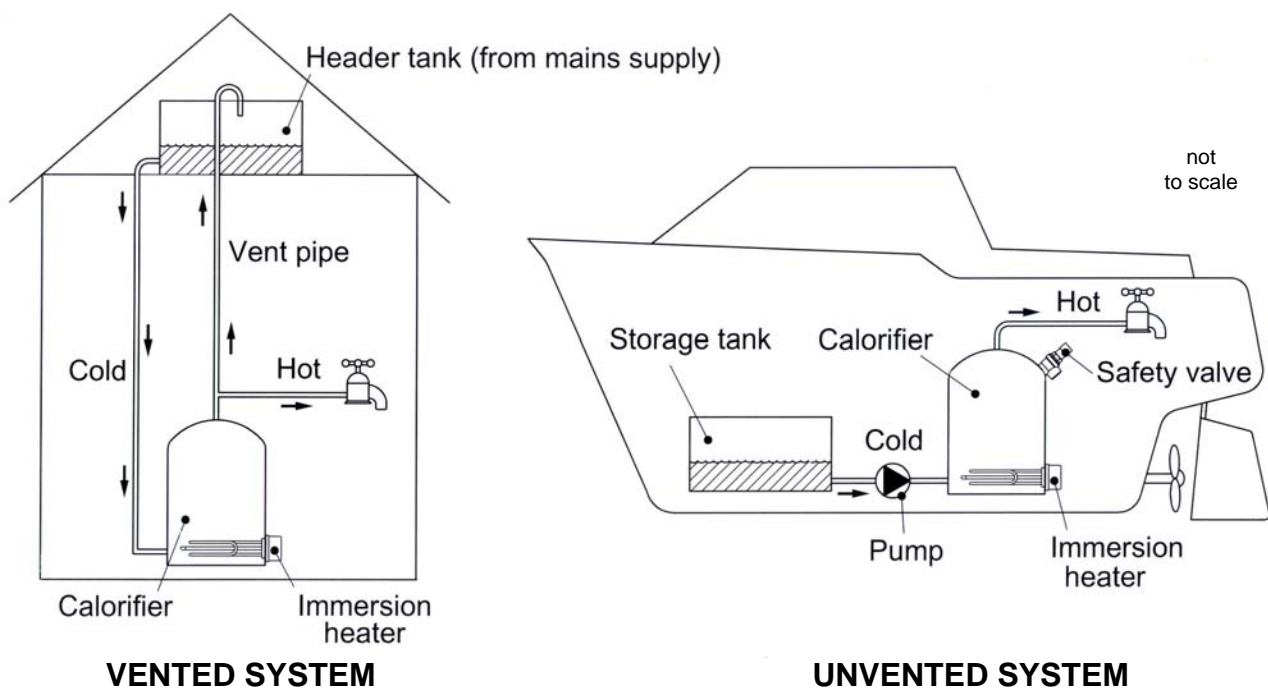

If my C-Warm or Seaward heater contains no water, is it safe for engine cooling water to circulate through the coil?

Yes. Engine cooling water can safely be circulated through the coil whether the heater is full of water, part full or empty.

Can I use a C-Warm or Seaward heater to heat seawater?

C-Warm and Seaward heaters are not recommended for use with seawater. Such use will invalidate the warranty.

Winter precautions?

To avoid the risk of freezing and possible damage in winter, drain the heater and leave it empty when not in use.

Warranty

C-Warm and Seaward heaters are guaranteed free from defects in material or workmanship for a period of three years from delivery to the purchaser. Full warranty details are available on request.

TECHNICAL SPECIFICATION

WORKING PRESSURE : **C-WARM COMPACT, C-WARM COMPACT Major and C-WARM MODULAR**
Up to 3 bar (3kg/cm², 300 kPa, 44lb/in²)

SEAWARD
Up to 5 bar (5kg/cm², 500 kPa, 73lb/in²)

TEST PRESSURE : 1.5 x maximum working pressure

TEMPERATURE/PRESSURE RELIEF VALVE Supplied with all C-WARM heaters
Set to lift at 3 bar (44 psi) or 95°C
Non-adjustable

Fitted to all SEAWARD heaters
Set to lift at 5 bar (73 psi) or 98°C
Non-adjustable



The temperature/pressure relief valve **must** be fitted to the heater before it is put into service, Failure to fit the relief valve will invalidate the C-Warm Warranty



WORKING TEMPERATURE: The recommended maximum continuous stored water temperature is 95°C which cannot be exceeded when the temperature/pressure relief valve is fitted.
The temperature of water available from hot taps should not be allowed to exceed 65°C.

MATERIALS OF CONSTRUCTION

C-WARM

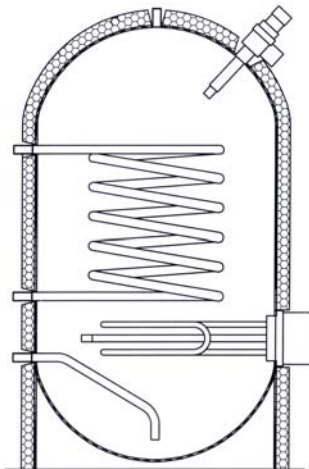

TANK	Copper	Grade C106 BS2870 (1980)
COIL(S)	Copper	BS2871 part 1 (1971)
BRAZING ALLOY		BS1845 (1984)
INSULATION	Closed cell polyurethane	Nominal thickness 20mm. Mean rate of heat loss less than 2 Watts per litre Flame retardant to BS699 (1983) Foaming agent non-CFC

CW IMMERSION HEATERS with double thermostat protection



Constructed to BS 3456 section 2.21 (1972)
 Element sheath: Incoloy 825
 Mounting head: Brass to CZ121, BS2874
 Terminal enclosure rated to IP21, BS EN 60529
 Main thermostat manually adjustable between 50°C and 80°C: Standard factory setting 60°C, automatic reset
 High level energy cut out adjustable up to 95°C maximum. Standard factory setting 95°C, manual reset

Immersion Heater Model No	a.c. voltage	Rated output kW	Recommended fuse size
CW423	220 - 240	3	13 amp
CW279	220 - 240	2	10 amp
CW278	220 - 240	1.25	5 amp
CW239	110 - 115	1	10 amp
CW240	220 - 240	0.75	3 amp

SEAWARD

Viewed from the top

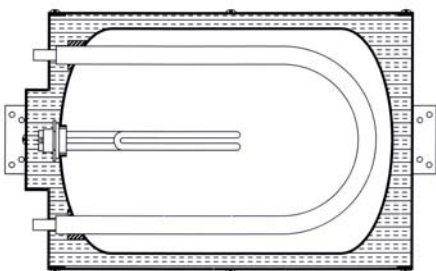

TANK	'Alcoa' clad Aluminium
COIL	Anodised Aluminium
ANODE	Magnesium
INSULATION	Rockwool
CASE	White-enamelled aluminium
IMMERSION HEATER (Integral)	Element sheath: Incoloy 825 Main thermostat: standard factory setting 60°C, automatic reset. High level energy cut-out: standard factory setting 88°C, manual reset



WATER STORAGE HEATERS QUOTATION/ORDER CHECKLIST

Qty	Model number/ part number	Description
	CWC	C-Warm or Seaward Compact heater
	CWB	C-Warm Modular heater
	CWA-STRKIT	Strap kit
	CWAB -.....	Bracket kit
	CWB-CKIT -.....	Connection kit
	CW(.....volts)	Electric immersion heater
	CW	Blender valve
	CW276	Cylinder thermostat
	CW	Non-return valve
	CW	Expansion tank

Name..... **Signed**.....

Address.....

.....

.....

Tel/fax/e-mail..... **Date**.....

.....

Distributed by:

Cleghorn Waring
Icknield Way
Letchworth Garden City
Herts
SG6 1EZ UK

tel: +44(0)1462 480380
fax: +44(0)1462 482422
e-mail: mail@cleghorn.co.uk
www.cleghorn.co.uk